



VALVES AND FITTINGS

CATÁLOGO CATALOGUE



HIDRO

	Introducción	01		Accesorio de latón a compresión con bridas tubería PE	104
	Introduction			Brass compression flange fitting PE pipes	
	Novedades	09		Riego: Accesorio de latón para tubería PE a presión	109
	News			Irrigation: Brass fitting for pressure PE pipes	
	Válvulas Platinum	20		Accesorio de latón para tubo de hierro	112
	Platinum valves			Brass compression fitting for iron pipe	
	Válvulas Gold	25		Accesorio y válvulas de latón a compresión para tubo de cobre e inoxidable	115
	Gold valves			Brass compression fitting and valves for copper and stainless steel pipe	
	Válvulas Silver	33		Accesorio de compresión para tubería multicapa y PEX	120
	Silver valves			Compression fitting for multilayer and PEX pipe	
	Grifos	37		Accesorio de prensar para tubería multicapa y PEX	127
	Bibcock range			Press fitting for multilayer and PEX pipe	
	Válvulas de escuadra	42		MT Garden	134
	Angle valves			MT Garden	
	Otras válvulas	48		Accesorio de hierro maleable galvanizado	140
	Other valves			Malleable galvanized iron fitting	
	Conexión flexible "latiguillo"	59		Varios	152
	Flexible connection			Others	
	Accesorio de latón roscado	62		Condiciones de venta	180
	Brass threaded fitting			Sales conditions	
	Accesorio de latón roscado cromado	76		Índice de referencias	182
	Chrome plated brass threaded fitting			References index	
	Válvulas flotador y boyas	82		Anexo	186
	Float valves and buoys			Annex	
	Accesorio de latón para tubería de cobre	86			
	Brass fitting for copper pipe				
	Accesorio de latón a compresión rosca hembra tubería PE	92			
	Brass compression fitting female threading PE pipes				
	Accesorio de latón a compresión rosca macho tubería PE	98			
	Brass compression fitting male threading PE pipes				

YEARS
25

1994_2019



Desde 1994, MT diseña, produce y comercializa una amplia gama de productos para el segmento hidrosanitario e industrial entre los que destacan los accesorios y las válvulas de latón, accesorios de acero inoxidable, bridas y válvulas industriales, entre otros.

Since 1994, MT has been designing, producing and marketing a wide range of products for the hydrosanitary and industrial segment, including brass valves and fittings, stainless steel fittings, flanges and industrial valves, among others.

La compañía basa su estrategia en la satisfacción del cliente con una excelente relación calidad precio en más de 4.000 referencias especialmente producidas para el profesional distribuidor.

The aim of the company is the customer satisfaction, trying to give the best quality – price combination in more than 4,000 references, specially made for the professional distributor.

Con una alta cuota de mercado, MT se posiciona como una de las empresas más completas en soluciones integrales para la conducción de fluidos, segmento clave para el sector industrial, tratamientos de agua y riego, usos hidrosanitarios, automatización, instrumentación, etc.

With a nice market presence, MT is positioned as one of the most complete companies in integral solutions for the conduction of fluids, key segment for the industrial sector, water and irrigation treatments, hydrosanitary uses, automation, instrumentation, etc.

Actualmente, MT cuenta con una red de distribuidores propios en más de 12 países, una filial en México (MT América), y clientes en 40 países de 4 continentes.

Nowadays, MT has a network of its own distributors in more than 12 countries, a subsidiary in Mexico (MT America) and clients in 40 countries on 4 continents.

MT es una multinacional española que fabrica y comercializa productos y accesorios para la canalización y conducción de fluidos en más de 40 países.

MT is an spanish company that manufactures and distributes products and accessories for the canalization and conduction of fluids in more than 40 countries.



PRODUCTOS

PRODUCTS

Todas las referencias de MT las encontrarás bajo dos grandes divisiones: Hidro e Industrial, con las que la compañía quiere dar una respuesta específica según el ámbito para el que se han diseñado.

MT portfolio of products are braced in two major divisions: Hydro and Industrial, and with those two divisions we try to give the specific solution on each situation.



La división Hidro MT agrupa todos los productos específicamente diseñados para la canalización y conducción de fluidos para los sectores de construcción, fontanería, riego y jardín.

Se trata de una amplia gama de productos en la que encontraremos accesorios de hierro maleable galvanizado, válvulas de latón y accesorios de latón, reductoras de presión, válvulas de PVC, válvulas y descargas para WC, manómetros, y una selección de los productos más importantes de MAC3, fabricante mundial de productos electrónicos para sistemas hidráulicos.

The Hidro MT division contains all the products, specifically designed for the canalization and conduction of fluids for the construction, plumbing, irrigation and gardening sectors.

It is a wide range of products in which we find malleable galvanized iron fittings, brass valves and brass fittings, pressure reducers, PVC valves, WC valves and discharges, manometers and a selection of the most important products of MAC3, an Italian manufacturer of electronic products for hydraulic systems.



INDUSTRIAL

La división Industrial ofrece piezas de gran calidad de acero inoxidable específicamente pensados para el ámbito industrial. Toda la gama está fabricada bajo estrictos parámetros de calidad cumpliendo con las más altas certificaciones en conducción de fluidos.

Se trata de una amplia gama de productos inox con referencias de bridas y valonas de acero inoxidable, accesorio roscado de acero inoxidable, accesorios para la soldadura de tubo inoxidable, MT Press para prensar, válvulas inoxidables, válvulas de fundición y automatismos.

The Industrial division offers high quality stainless steel parts specifically designed for the industrial sector. The entire range is manufactured under strict quality parameters that comply with the highest certifications in conducting fluids.

It is a wide range of stainless steel products including stainless steel flanges, threaded fittings, welding accessories, MT press fitting, valves, casting valves, ductile valves and automatism.



CERTIFICADOS

CERTIFICATIONS

Desde su creación, MT ha apostado por fijar objetivos de calidad e innovación sobre los que construir productos eficientes, seguros, duraderos y altamente rentables. La compañía permanece totalmente alineada con la legislación Europea, cada vez más estricta en sus políticas medioambientales, seguridad e higiene, y apuesta por el desarrollo continuo de nuevas líneas de producción. MT es hoy referente en calidad y homologaciones.

Since its inception, MT has focused its efforts on establishing quality and innovation objectives to build efficient, safe, durable and highly profitable products. The company remains fully aligned with European legislation, keeping ourselves strict in its policies on environment, safety and hygiene, and is committed to the continuous development of new production lines. MT is now a benchmark in quality and approvals.

EMPRESA

COMPANY

Certificado TÜV para la Gestión de la Calidad

La organización demuestra su capacidad para proporcionar de forma coherente productos o servicios que satisfacen los requisitos del cliente y los reglamentos aplicables según la norma UNE-EN ISO 9001.

TÜV Quality Management Certificate

The organization demonstrates its ability to consistently deliver products or services that meet customer and regulatory requirements applicable to UNE-EN ISO 9001.

PRODUCTOS

PRODUCTS



La Asociación alemana del sector de gas y agua (DVGW) certifica, entre otros, materiales de sellado para el abastecimiento de gas en Alemania.

The German Association of the Gas and Water Industry (DVGW) certifies, among other things, sealing materials for gas supply in Germany.



Certificación para el empleo de materiales de juntas de sellado con agua potable de acuerdo con la norma británica BS 6920.

Certification for the use of sealing gasket materials with drinking water in accordance with British Standard BS 6920.



Autorización oficial expedida por la Dirección General Sanitaria francesa desde 1998. Se aplica a los materiales constitutivos de los equipos que están en contacto con el agua destinada al consumo humano así como a los equipos en sí.

Official authorization issued by the General Directorate of Health since 1998 (ACS certification). It is applied to equipment constituting materials that are in contact with water intended for human consumption, as well as to the equipment itself.



Autorización oficial expedida por Le Centre Scientifique et Technique du Bâtiment (CSTB).

Official authorization issued by the Center Scientific et Technique du Bâtiment (CSTB).



Certificación de sistemas de tubería multicapa para instalaciones de agua potable (caliente y fría) en edificación de acuerdo con la normativa EN ISO 21003.

Certification of multilayer piping systems for hot and cold drinking water inside buildings in accordance with EN ISO 21003.



Certificado de sistema tubería PE-X para instalaciones de agua caliente y fría en instalaciones de agua sanitaria y calefacción de acuerdo a normativa UNE-EN ISO 15875 y BRL 5606.

Certification of PE-X piping systems for hot and cold drinking water and heating installations in accordance with UNE-EN ISO 15875 and BRL 5606.



Certificación conforme el producto cumple con la normativa UNE-EN 13828 (diseño) y la NKB-13 (migración metales pesados).

Certification according the product complies with UNE-EN 13828 (design) and NKB-13 (heavy metal migration).



Certificación oficial expedida por el Instituto Nacional de Sanidad Pública de Polonia. Se aplica a los materiales constitutivos de los equipos que están en contacto con el agua destinada al consumo humano.

Official certificate issued by the National Institute of Public Hygiene of Poland. It is applied to equipment constituting materials that are in contact with water intended for human consumption.



Certificación de conformidad para los productos que cumplen con todos los reglamentos técnicos de la Unión Aduanera Euroasiática.

Product compliance Certificate according to the technical regulations of the Eurasian Custom Union.

VALOR DIFERENCIAL

DIFERENCIAL VALUE

MT se ha posicionado en el mercado como una de las empresas más ágiles en capacidad de respuesta, relación calidad-precio y catálogo de referencias.

La compañía ha definido una estrategia comercial basada en precios competitivos y una máxima preocupación: no sobre-estocar al cliente. Esto nos permite ajustar la producción a las necesidades reales del mercado y sus profesionales y ofrecer:

MT has positioned itself in the market as one of the most agile companies in terms of responsiveness, value for money and reference catalog.

The company has defined its commercial strategy based on competitive prices and a maximum concern: not over-store the customer. This allows us to adjust production to the real needs of the market and its professionals and offer:



MT ha consolidado una red de distribución internacional, entendiendo las especificidades que marca cada mercado y adaptando certificaciones y requerimientos de cada país.

El modelo logístico pone el foco en la anticipación y la capacidad de respuesta en un amplio catálogo de productos. Esto es posible, entre otros, gracias al código EAN incorporado en cada uno de sus productos, imprescindible para un óptimo control de los stocks y la venta de productos por línea de caja.

MT has consolidated an international distribution network, understanding the specificities that mark each market and adapting the certifications and requirements of each country.

The logistic model puts the focus on anticipation and responsiveness in a wide product catalog. This is possible, among others, thanks to the EAN code incorporated in each of its products, essential for optimum control of stocks and the sale of products on counters.

Condiciones válidas sólo en España
Valid conditions only in Spain



Nuevo servicio urgente 24h.
New urgent service 24h.



Amplio catálogo de productos
con más de 4.000 referencias
Wide catalog of products with
more than 4.000 references



Producción homologada según
normativas y certificaciones
Production approved according
to regulations and certifica-
tions



Servicio logístico que vela por
el no sobre-estocaje del cliente
Logistic service that monitors
non-storage



Atención al cliente basada en
la inmediatez y la flexibilidad
Customer support based on
immediacy and flexibility

Consultar condiciones de venta página 268
See sales conditions on page 268



Tel. +34 **936 804 980**
Fax. +34 **936 804 981**

www.mtspain.net
info@mtspain.net

Pol. Sector Camps d'en Ricart
C/ Comerç, 10, naves 3 a 9
08780 Pallejà, Barcelona - SPAIN

MT®
VALVES AND FITTINGS

NOVEDADES NEWS

Cajas dispensadoras completamente personalizables, blisters y embolsados. Todo para facilitar su correcta identificación y clasificación.

Dispenser boxes completely customizable, blister packs and bagged. All to facilitate its correct identification and classification.

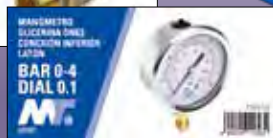



SOLUCIONES DE MARKETING A MEDIDA

CUSTOMIZED MARKETING SOLUTIONS

Dos factores determinan los resultados en el punto de venta: visibilidad y notoriedad. Ser capaces de llamar la atención del consumidor y transmitir el concepto y las principales ventajas técnicas del producto es otro de nuestros máximos objetivos.

MT pone a disposición de sus clientes un completo abanico de soluciones orientadas a reforzar sus acciones comerciales en el punto de venta con un fin: reforzar la identidad corporativa de los productos ofertados y facilitar al máximo la venta.

- Acciones de marketing promocional
- Comunicación retail
- Productos dotados de herramientas comerciales especialmente creadas: expositor, bolsas, etiquetas, categorías, muestras, etc.

There are two factors that determine the results in point of sale: visibility and notoriety. Be able to attract attention of customers and transmit the concept and the main technical advantages of our products is other of our main goals.

MT makes available to the customers a complete variety of solutions oriented to reinforce his point of sale commercial actions with a goal: reinforce the corporate identity of the quoted products and facilitate at maximum the sale..

- Promotional marketing actions
- Retail communication
- Products equipped with commercial tools specially designed for them: exhibitor, bags, labels, categories, samples, etc.

NUESTRAS HERRAMIENTAS COMERCIALES

- Implantaciones por familias de productos.
- Cajas dispensadoras etiquetadas para estanterías modulares.
- Expositores para válvulas de llenado y descarga.
- Box palet para punto de venta.

OUR COMMERCIAL TOOLS

- Establishments by product families.
- Dispenser boxes labeled for modular shelves.
- Exhibitors for flush and fill valves.
- Box pallet for point of sale.





Box pallet personalizable para punto de venta.
Customizable box pallet for point of sale.



Expositores para la familia de válvulas de llenado y descarga de wc.
Expositors for our Flush & fill valves range.

IMPLANTACIONES POR FAMILIAS DE PRODUCTOS



Estas implantaciones se han diseñado en base a un estudio de mercado realizado a nivel nacional, con las referencias de más rotación. El cliente puede modificar o cambiar cualquier artículo por las necesidades de su zona o tipología de mercado al que va dirigido el producto.

These implementations have been designed based on the market development, choosing the references with high rotation. The customer can modify the item shown according to the needs of their area or market.

CÓDIGOS EAN

EAN CODES

Para un mayor control de los stocks, eliminando posibles errores en los precios, para la solicitud de pedidos con un código único y compatible con el programa de gestión internacional EDI.

For better stock control, in order to avoid possible mistakes in prices, for the request of orders with a unique code and compatible with the international management program EDI.

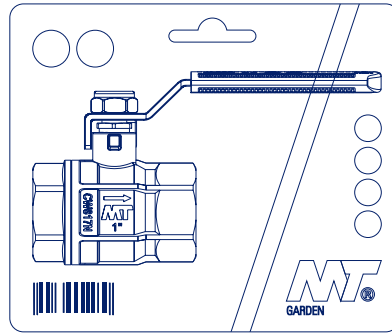

HANGTAGS

HANGTAGS

Etiqueta individual por artículo, donde se facilita la información de la referencia del producto, certificaciones, medidas y código EAN 13.

Every article comes individually labeled, and this label comes with the product reference information, certifications, measurements and EAN 13 code



SERIE 87 NUEVAS REFERENCIAS

87 SERIES
NEW REFERENCES



87093

CODO 90° M-M
M-M ELBOW 90°



87098

CODO 90° M-H CON CONECTOR 2 PIEZAS
M-F ELBOW 90° WITH 2 PIECES CONNECTOR



87132

TE IGUAL MACHO
M EQUAL TEE



87500

RACOR CODO MURAL H-H
F-F WALL PLATED ELBOW



87575

ANILLO REDUCIDO H-M
REDUCING RING F-M



ACCESORIO DE LATÓN ROSCADO CROMADO

CHROME PLATED BRASS
THREADED FITTING

PRESIÓN MÁXIMA DE TRABAJO
MAXIMUM WORKING PRESSURE



CARACTERÍSTICAS GENERALES GENERAL FEATURES

Estampado en caliente
Hot forged

Cuerpo en latón cromado
Chromed-plated brass body

Rosca macho paralela / Rosca hembra paralela
Parallel male thread / Parallel female thread



Ref. 871090
Codo 90° H-H
F-F Elbow 90°



Ref. 871092
Codo 90° M-H
M-F Elbow 90°



Ref. 871500
Racor codo mural
Wall plated elbow



Ref. 871130
Tee igual H
F Equal tee



Ref. 871240
Manguito r educción H-H
F-F Reducing socket



Ref. 871241
Tuerca reducción M-H
M-F reducing bushings



Ref. 871245
Machón reducido M-M
M-M Reducing nipple



Ref. 871246
Manguito reducción M-H
M-F Reducing nipple socket



Ref. 871270
Manguito H-H
F-F socket



Ref. 871280
Machón M-M
M-M hexagon nipple



Ref. 871290
Tapón con reborde M
M plug beaded



Ref. 871300
Tapón hexagonal H
F hexagon cap



Ref. 871529
Manguito igual M-H
"tipo marsella"
M-F equal socket
'marsella type'



Ref. 87534
Alargadera M-H (hex. interior)
M-F extension fitting (hexagon inside)



Ref. 871531
Manguito igual M-H
(hexágono interior)
M-F Equal socket
(hexagon inside)

pag. **MT®**
82

VÁLVULAS DE FLOTADOR Y BOYAS

FLOAT VALVES AND BUOYS

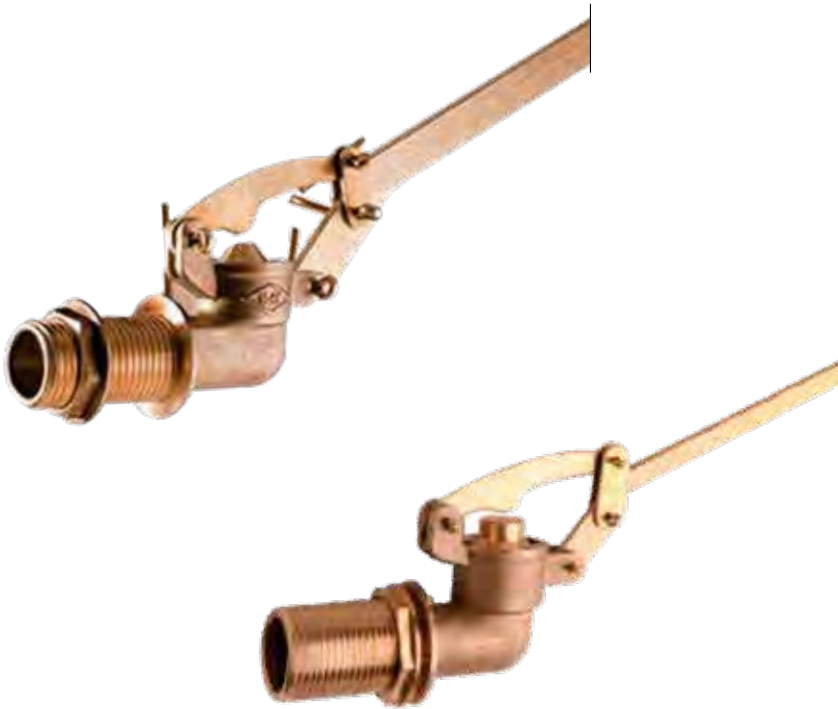



FLEXO DE DUCHA FLEXIBLE DE PVC

FLEXIBLE PVC SHOWER HOSE



pag. **MT®**
59

CONEXIÓN FLEXIBLE "LATIGUILLO"

FLEXIBLE CONNECTION





LIMPIADOR PARA POLIETILENO

POLYETHYLENE CLEANER



VÁLVULAS DE LATÓN

BRASS VALVES



SERIES

PLATINUM

GOLD

SILVER

La amplia gama de válvulas MT pretende cubrir todas las necesidades del mercado intentando satisfacer las diferentes particularidades en todas las zonas del territorio internacional y las distintas aplicaciones en sectores como la industria, fontanería, calefacción, riego, etc...

Para ello, disponemos de válvulas PN-16, PN-25, PN-30 y PN-40, con cierre metálico y cierre elástico, distinto rango de temperaturas máximas, fluidos, lubricantes, hidrocarburos, alivio de presión y sistema antihielo, así como la disposición de accionamiento mediante palanca, palomilla, volante o cuadradillo y la posibilidad de conectar algunos modelos a tuberías de cobre, PEX, multicapas, por compresión en tuberías rígidas, polietileno o a través de rosca gas, H-H, M-H y M-M.

También tenemos a su disposición recambios para alargaderas, racores para la adaptación de mangueras, tamices para los filtros "Y" así como mandos con sus correspondientes florones para las válvulas de empotrar.

The wide range of MT valves tries to cover every needs of the market trying to satisfy all particularities in every zone of the international territory and the different applications in sectors such as Industry, Plumbing, Heating, Irrigation, etc.

That's why we have valves from PN-16 to PN-40, with metallic closing and resilient wedge, different range of temperatures, fluids, lubricants, hydrocarbons, relief of pressure and nofrost system, as well as the disposition of operation by plane handle, butterfly handle, hand wheel or square handle for connecting some models to copper pipelines, PEX, Multilayer, for compression rigid pipelines, polyethylene or throw gas thread, F-F, M-F and M-M.

In addition, we can offer spare parts for elongations, fittings for hose connections, filters for the Strainer Filter 'Y' and handles with their rossetes for solder ball valve.



PLATINUM SERIES

PN40

VÁLVULA DE BOLA
BALL VALVE

ANTI CORROSIÓN ANTIHIELO

ANTI RUST NOFROST

DZR
BRASS



- Paso total
- Sistema Antihielo
- Cuerpo reforzado
- Latón DZR CW602N
- Eje en acero inoxidable
- Nueva maneta ergonómica en acero inoxidable con tuerca autoblocante. Alta resistencia frente a la corrosión
- Juntas en FKM
- -20°C / 180°C
- Full bore
- Nofrost System
- Reinforced body
- DZR Brass CW602N
- Stainless steel stem
- New ergonomic stainless steel handle with self-locking nut. High protection from corrosion
- FKM o' rings
- -20°C / 180°C



LEYENDA DE ICONOS

ICON KEY

Posibles codificaciones aplicadas en esta sección.

Possible encodings applied in this section.

ACS

SINTEF



DZR



Latón DZR
DZR Brass

Antihielo
Nofrost
system

Código de barras EAN
EAN bar code

CERTIFICADOS DE PRODUCTO
PRODUCT CERTIFICATES

PROPIEDADES DE PRODUCTO
PRODUCT PROPERTIES

4104

ACS **SINTEF** **PLATINUM** *

VÁLVULA ESFERA PN-40 H-H PASO TOTAL EN LATÓN DZR PALANCA ERGONÓMICA COLOR NEGRO ACERO INOXIDABLE
F-F DZR BRASS BALL VALVE PN-40 FULL BORE WITH BLACK ERGONOMIC STAINLESS STEEL HANDLE

**ANTIHIELO
NOFROST**

DZR



CÓDIGO	MEDIDA			€
CODE	SIZE			€
4104-015	1/2"	48	12	9,11
4104-020	3/4"	32	8	13,86
4104-025	1"	20	5	22,49
4104-032	1 1/4"	12	3	33,68
4104-040	1 1/2"	12	2	50,18
4104-050	2"	12	2	74,92

4504

ACS **SINTEF** **PLATINUM** *

VÁLVULA ESFERA PN-40 M-H PASO TOTAL EN LATÓN DZR PALANCA ERGONÓMICA COLOR NEGRO ACERO INOXIDABLE
M-F DZR BRASS BALL VALVE PN-40 FULL BORE WITH BLACK ERGONOMIC STAINLESS STEEL HANDLE

**ANTIHIELO
NOFROST**

DZR



CÓDIGO	MEDIDA			€
CODE	SIZE			€
4504-015	1/2"	40	10	9,48
4504-020	3/4"	24	6	14,42
4504-025	1"	16	4	23,38
4504-032	1 1/4"	12	3	35,03
4504-040	1 1/2"	12	2	52,19
4504-050	2"	12	1	77,91

4204



ACS SINTEF PLATINUM * 

VÁLVULA ESFERA PN-40 H-H PASO TOTAL EN LATÓN DZR MANDO PALOMILLA COLOR NEGRO
F-F DZR BRASS BALL VALVE PN-40 FULL BORE WITH BLACK BUTTERFLY HANDLE

ANTIHIELO
NOFROST

DZR



CÓDIGO	MEDIDA			€
CODE	SIZE			€
4204-015	1/2"	60	15	9,29
4204-020	3/4"	44	11	14,13
4204-025	1"	28	7	22,94

4604



ACS SINTEF PLATINUM * 

VÁLVULA ESFERA PN-40 M-H PASO TOTAL EN LATÓN DZR MANDO PALOMILLA COLOR NEGRO
M-F DZR BRASS BALL VALVE PN-40 FULL BORE WITH BLACK BUTTERFLY HANDLE

ANTIHIELO
NOFROST

DZR



CÓDIGO	MEDIDA			€
CODE	SIZE			€
4604-015	1/2"	60	15	9,59
4604-020	3/4"	44	11	14,42
4604-025	1"	28	7	23,40

494081

PLATINUM **INOX** **R**

RECAMBIO - MANETA ACERO INOXIDABLE COLOR NEGRO PARA VÁLVULA PN-40
SPARE PART - STAINLESS STEEL BLACK HANDLE FOR PN-40 BALL VALVE



CÓDIGO	MEDIDA			€
CODE	SIZE			€
	1/2"	240	1	
494081-1520	3/4"	240	1	1,53
494081-0025	1"	120	1	2,21
494081-0032	1 1/4"	80	1	3,50
494081-0040	1 1/2"	120	1	5,01
494081-0050	2"	120	1	5,30

GOLD SERIES



PN30

VÁLVULA DE BOLA
BALL VALVE

ANTIHIELO

NOFROST



- Paso total
- Sistema Antihielo
- Certificado ACS
- Cuerpo reforzado
- Latón CW617N
- Nueva maneta ergonómica en acero inoxidable con tuerca autoblocante.
- -20°C / 120°C

- Full bore
- Nofrost System
- ACS certified
- Reinforced body
- Brass CW617N
- New ergonomic stainless steel handle with self-locking nut. -20°C / 120°C



PN
30

LEYENDA DE ICONOS ICON KEY

Posibles codificaciones aplicadas en esta sección.

Possible encodings applied in this section.



CERTIFICADOS DE PRODUCTO
PRODUCT CERTIFICATES



Antihielo
Nofrost
system

Código de barras EAN
EAN bar code

PROPIEDADES DE PRODUCTO
PRODUCT PROPERTIES

4295



GOLD 

VÁLVULA ESFERA PN-30 H-H
PASO TOTAL PALANCA ERGO-
NÓMICA COLOR ROJO ACERO
INOXIDABLE / F-F BRASS
BALL VALVE PN-30 FULL BORE
RED ERGONOMIC STAINLESS
STEEL HANDLE



WRAS
ACS
PZH

**ANTIHIELO
NOFROST**

CÓDIGO	MEDIDA			€
CODE	SIZE			€
4295-008	1/4"	72	12	5,02
4295-010	3/8"	72	12	5,02
4295-015	1/2"	54	9	6,57
4295-020	3/4"	36	9	9,51
4295-025	1"	24	6	14,48
4295-032	1 1/4"	16	4	24,34
4295-040	1 1/2"	8	2	35,00
4295-050	2"	12	2	55,67
4295-065	2 1/2"	6	1	106,56
4295-080	3"	4	1	165,06
4295-100	4"	2	1	226,16

42952



GOLD 

VÁLVULA ESFERA PN-30 H-H
PASO TOTAL PALANCA ERGO-
NÓMICA COLOR AZUL ACERO
INOXIDABLE / F-F BRASS
BALL VALVE PN-30 FULL BORE
BLUE ERGONOMIC STAINLESS
STEEL HANDLE



WRAS
ACS
PZH

**ANTIHIELO
NOFROST**

CÓDIGO	MEDIDA			€
CODE	SIZE			€
42952-008	1/4"	72	12	5,02
42952-010	3/8"	72	12	5,02
42952-015	1/2"	54	9	6,57
42952-020	3/4"	36	9	9,51
42952-025	1"	24	6	14,48
42952-032	1 1/4"	16	4	24,34
42952-040	1 1/2"	8	2	35,00
42952-050	2"	12	2	55,67
42952-065	2 1/2"	6	1	106,56
42952-080	3"	4	1	165,06
42952-100	4"	2	1	226,16

4097



GOLD 

VÁLVULA ESFERA PN-30 M-H
PASO TOTAL PALANCA ERGO-
NÓMICA COLOR ROJO ACERO
INOXIDABLE / M-F BRASS
BALL VALVE PN-30 FULL BORE
RED ERGONOMIC STAINLESS
STEEL HANDLE



WRAS
ACS
PZH

**ANTIHIELO
NOFROST**

CÓDIGO	MEDIDA			€
CODE	SIZE			€
4097-010	3/8"	72	12	5,04
4097-015	1/2"	54	9	6,78
4097-020	3/4"	36	9	9,80
4097-025	1"	24	6	14,91
4097-032	1 1/4"	16	4	25,05
4097-040	1 1/2"	8	2	35,95
4097-050	2"	12	2	57,35

40972



GOLD 

VÁLVULA ESFERA PN-30 M-H
PASO TOTAL PALANCA ERGO-
NÓMICA COLOR AZUL ACERO
INOXIDABLE / M-F BRASS
BALL VALVE PN-30 FULL BORE
BLUE ERGONOMIC STAINLESS
STEEL HANDLE



WRAS
ACS
PZH

**ANTIHIELO
NOFROST**

CÓDIGO	MEDIDA			€
CODE	SIZE			€
40972-010	3/8"	72	12	5,04
40972-015	1/2"	54	9	6,78
40972-020	3/4"	36	9	9,80
40972-025	1"	24	6	14,91
40972-032	1 1/4"	16	4	25,05
40972-040	1 1/2"	8	2	35,95
40972-050	2"	12	2	57,35

4098

GOLD 

VÁLVULA ESFERA PN-30 M-M
PASO TOTAL PALANCA ERGO-
NÓMICA COLOR ROJO ACERO
INOXIDABLE / M-M BRASS
BALL VALVE PN-30 FULL BORE
RED ERGONOMIC STAINLESS
STEEL HANDLE



**ANTIHIELO
NOFROST**



WRAS

ACS

PZH

CÓDIGO	MEDIDA			€
CODE	SIZE			€
4098-015	1/2"	48	12	7,12
4098-020	3/4"	36	9	10,28
4098-025	1"	24	6	15,66
4098-032	1 1/4"	12	3	26,29
4098-040	1 1/2"	12	2	37,84
4098-050	2"	12	2	60,20

40982

GOLD 

VÁLVULA ESFERA PN-30 M-M
PASO TOTAL PALANCA ERGO-
NÓMICA COLOR AZUL ACERO
INOXIDABLE / M-M BRASS
BALL VALVE PN-30 FULL BORE
BLUE ERGONOMIC STAINLESS
STEEL HANDLE



**ANTIHIELO
NOFROST**



WRAS

ACS

PZH

CÓDIGO	MEDIDA			€
CODE	SIZE			€
40982-015	1/2"	48	12	7,12
40982-020	3/4"	36	9	10,28
40982-025	1"	24	6	15,66
40982-032	1 1/4"	12	3	26,29
40982-040	1 1/2"	12	2	37,84
40982-050	2"	12	2	60,20

4106

GOLD 



VÁLVULA ESFERA DOS PIEZAS PN-30 M-H MANDO PALOMILLA
COLOR AZUL / M-F BALL VALVE PN-30 WITH TWO PIECES CON-
NECTOR AND BLUE BUTTERFLY HANDLE



WRAS

ACS

PZH

CÓDIGO	MEDIDA			€
CODE	SIZE			€
4106-015	1/2"	54	9	11,48
4106-020	3/4"	36	9	13,92
4106-025	1"	24	6	20,30
4106-032*	1 1/4"	8	2	33,36
4106-040*	1 1/2"	12	2	45,42
4106-050*	2"	6	1	71,10

41062

GOLD 



VÁLVULA ESFERA DOS PIEZAS PN-30 M-H MANDO PALOMILLA
COLOR ROJO / M-F BALL VALVE PN-30 WITH TWO PIECES CON-
NECTOR AND RED BUTTERFLY HANDLE



WRAS

ACS

PZH

CÓDIGO	MEDIDA			€
CODE	SIZE			€
41062-015	1/2"	54	9	11,48
41062-020	3/4"	36	9	13,92
41062-025	1"	24	6	20,30

- * Solo disponible en palanca en acero inoxidable
- * Only available stainless steel handle

4102

GOLD 

VÁLVULA ESFERA PN-30 H-H PASO TOTAL MANDO PALOMILLA
COLOR ROJO F-F BRASS BALL VALVE PN-30 FULL BORE WITH
RED BUTTERFLY HANDLE

**ANTIHELO
NOFROST**



WRAS
ACS
PZH

41022



GOLD 



VÁLVULA ESFERA PN-30 H-H PASO TOTAL MANDO PALOMILLA
COLOR AZUL F-F BRASS BALL VALVE PN-30 FULL BORE WITH
BLUE BUTTERFLY HANDLE

**ANTIHELO
NOFROST**



WRAS
ACS
PZH

CÓDIGO	MEDIDA			€
CODE	SIZE			€
4102-010	3/8"	72	12	5,04
4102-015	1/2"	60	10	6,47
4102-020	3/4"	36	9	9,30
4102-025	1"	24	6	14,24

CÓDIGO	MEDIDA			€
CODE	SIZE			€
41022-010	3/8"	72	12	5,02
41022-015	1/2"	60	10	6,47
41022-020	3/4"	36	9	9,30
41022-025	1"	24	6	14,24

4103

GOLD 

VÁLVULA ESFERA PN-30 M-H PASO TOTAL MANDO PALOMILLA
COLOR ROJO M-F BRASS BALL VALVE PN-30 FULL BORE WITH
RED BUTTERFLY HANDLE

**ANTIHELO
NOFROST**



WRAS
ACS
PZH

41032



GOLD 



VÁLVULA ESFERA PN-30 M-H PASO TOTAL MANDO PALOMILLA
COLOR AZUL M-F BRASS BALL VALVE PN-30 FULL BORE WITH
BLUE BUTTERFLY HANDLE

**ANTIHELO
NOFROST**



WRAS
ACS
PZH

CÓDIGO	MEDIDA			€
CODE	SIZE			€
4103-008	1/4"	72	12	5,59
4103-010	3/8"	72	12	5,59
4103-015	1/2"	60	10	6,87
4103-020	3/4"	36	9	10,12
4103-025	1"	24	6	15,61

CÓDIGO	MEDIDA			€
CODE	SIZE			€
41032-008	1/4"	72	12	5,59
41032-010	3/8"	72	12	5,59
41032-015	1/2"	60	10	6,87
41032-020	3/4"	36	9	10,12
41032-025	1"	24	6	15,61

4100



VÁLVULA ESFERA PN-30 PALANCA INOX. COLOR ROJO CON CONEXIÓN PE BALL VALVE PN-30 RED S.S. HANDLE WITH CONNECTIONS PE



CÓDIGO CODE	MEDIDA SIZE			€ €
4100-020	20	24	6	16,30
4100-025	25	16	4	23,96
4100-032	32	12	3	34,73

4101



VÁLVULA ESFERA PN-30 PALANCA INOX. COLOR ROJO CON CONEXIÓN PE-H BALL VALVE PN-30 RED S.S. HANDLE WITH CONNECTIONS PE-H



CÓDIGO CODE	MEDIDA SIZE			€ €
4101-01520	1/2" x 20	32	8	12,93
4101-02025	3/4" x 25	24	6	18,82
4101-02532	1" x 32	16	4	27,68

4107



VÁLVULA ESFERA SOLDAR PN-30 PALANCA EN ACERO CROMADO SOLDER END BALL VALVE PN-30 WITH CHROMED STEEL HANDLE



CÓDIGO CODE	MEDIDA SIZE			€ €
4107-015	15	48	8	5,60
4107-018	18	48	8	5,82
4107-022	22	36	6	8,74
4107-028	28	16	4	13,01
4107-035	35	12	2	22,44
4107-042	42	12	2	33,40
4107-054*	54	6	1	44,36

4108



VÁLVULA ESFERA SOLDAR PN-30 MANDO PALOMILLA SOLDER END BALL VALVE PN-30 BUTTERFLY HANDLE



CÓDIGO CODE	MEDIDA SIZE			€ €
4108-015	15	54	9	5,38
4108-018	18	54	9	5,55
4108-022	22	42	7	8,28
4108-028	28	20	5	13,13

- *Disponible hasta agotar existencias
*While stocks lasts

4124

ACS



VÁLVULA ESFERA CUADRADILLO H-H (27mm.)
F-F BALL VALVE SQUARE HANDLE (27mm.)



CÓDIGO	MEDIDA			€
CODE	SIZE			€
4124-015	1/2"	48	12	10,29
4124-020	3/4"	36	9	12,04
4124-025	1"	24	6	16,15
4124-032	1 1/4"	16	4	23,04
4124-040	1 1/2"	8	2	33,66
4124-050	2"	8	1	50,41

4099



VÁLVULA ESFERA H-H DOBLE TOMA CON PURGA PALANCA
DE ACERO INOXIDABLE F-F BALL VALVE WITH DOUBLE OUTLET
STAINLESS STEEL HANDLE



CÓDIGO	MEDIDA			€
CODE	SIZE			€
4099-015	1/2"	20	5	8,48
4099-020	3/4"	16	4	12,33
4099-025	1"	12	3	16,47
4099-032	1 1/4"	12	2	25,33
4099-040	1 1/2"	12	2	38,81

4105

ACS



VÁLVULA ESFERA CUADRADILLO H-H
F-F BALL VALVE SQUARE HANDLE



CÓDIGO	MEDIDA			€
CODE	SIZE			€
4105-015*	1/2"	60	10	7,93
4105-020*	3/4"	36	9	10,70
4105-025*	1"	24	6	14,13
4105-032*	1 1/4"	16	4	24,84
4105-040**	1 1/2"	8	2	33,39
4105-050**	2"	8	1	52,78

- * Cuadradillo 20mm. / ** Cuadradillo 24,5mm.
* Square handle 20mm. / ** Square handle 24,5mm.

4221



VÁLVULA ESFERA EMPOTRAR PN-30 TERMINAL SOLDAR "CARLA"
LONG NECK SOLDER BALL VALVE PN-30 "CARLA" TYPE



CÓDIGO	MEDIDA			€
CODE	SIZE			€
4221-015	15	40	10	9,06
4221-018	18	40	10	9,20
4221-022	22	32	8	11,70

- Lado del cuadradillo 8x8mm. en todas las dimensiones
Side of square 8x8mm. in all dimensions

4222



VÁLVULA ESFERA EMPOTRAR H-H PN-30 "CARLA" ROSCAR
LONG NECK BALL VALVE F-F PN-30 'CARLA' TYPE, THREADED



CÓDIGO	MEDIDA			€
CODE	SIZE			€
4222-015	1/2"	48	12	9,23
4222-020	3/4"	32	8	13,01
4222-025	1"	24	6	17,90

- Lado del cuadradillo 8x8mm. en todas las dimensiones
Side of square 8x8mm. in all dimensions

42642



VÁLVULA ESFERA EMPOTRAR CONEXIÓN MULTICAPA PRENSAR
LONG NECK MULTILAYER BALL VALVE



CÓDIGO	MEDIDA	ESPESOR			€
CODE	SIZE	THICKNESS			€
42642-016	16	2.0	32	8	11,83
42642-020	20	2.0	32	8	12,50
42642-025	25	2.5	24	6	17,17
42642-026	26	3.0	24	6	17,26
42642-032	32	3.0	12	3	24,72

40642



VÁLVULA ESFERA CONEXIÓN MULTICAPA PRENSAR CON PALANCA
COLOR ROJO DE ACERO INOXIDABLE / MULTILAYER PRESS
BALL VALVE WITH RED STAINLESS STEEL HANDLE



CÓDIGO	MEDIDA	ESPESOR			€
CODE	SIZE	THICKNESS			€
40642-016	16	2.0	32	8	11,07
40642-020	20	2.0	32	8	12,03
40642-025	25	2.5	16	4	14,46
40642-026	26	3.0	16	4	14,62
40642-032	32	3.0	16	4	21,28

41642



VÁLVULA ESFERA CONEXIÓN MULTICAPA PRENSAR
CON MANDO PALOMILLA COLOR ROJO / MULTILAYER PRESS
BALL VALVE WITH RED BUTTERFLY HANDLE



CÓDIGO	MEDIDA	ESPESOR			€
CODE	SIZE	THICKNESS			€
41642-016	16	2.0	48	12	11,19
41642-020	20	2.0	48	12	12,26
41642-025	25	2.5	28	7	14,64
41642-026	26	3.0	28	7	14,73
41642-032	32	3.0	16	4	21,49

493080

GOLD / **INOX** **R**

RECAMBIO - MANETA ACERO INOXIDABLE COLOR AZUL PARA VÁLVULA PN-30 / SPARE PART STAINLESS STEEL BLUE HANDLE FOR PN-30 BALL VALVE



CÓDIGO	MEDIDA			€
CODE	SIZE			€
	1/4"	210	35	
493080-0815	3/8"	210	35	1,28
	1/2"	210	35	
493080-0020	3/4"	240	60	1,46
493080-0025	1"	180	45	2,10
493080-0032	1 1/4"	80	20	3,32
493080-0040	1 1/2"	72	18	4,77
493080-0050	2"	180	30	5,01

493082

GOLD / **INOX** **R**

RECAMBIO - MANETA ACERO INOXIDABLE COLOR ROJO PARA VÁLVULA PN-30 / SPARE PART - STAINLESS STEEL RED HANDLE FOR PN-30 BALL VALVE



CÓDIGO	MEDIDA			€
CODE	SIZE			€
	1/4"	210	35	
493082-0815	3/8"	210	35	1,28
	1/2"	210	35	
493082-0020	3/4"	240	60	1,46
493082-0025	1"	180	45	2,10
493082-0032	1 1/4"	80	20	3,32
493082-0040	1 1/2"	72	18	4,77
493082-0050	2"	120	30	5,01

SILVER SERIES



PN25
VÁLVULA DE BOLA
BALL VALVE

ANTI CORROSIÓN

ANTI RUST



- Latón CW617N
- Nueva maneta negra ergonómica con recubrimiento de alta resistencia frente a la corrosión.
- -20°C / 120°C
- Brass CW617N
- New ergonomic black handle with high protection coating from corrosion.
- -20°C / 120°C



LEYENDA DE ICONOS ICON KEY

Posibles codificaciones aplicadas en esta sección.

Possible encodings applied in this section.



CERTIFICADOS DE PRODUCTO
PRODUCT CERTIFICATES



Código de barras EAN
EAN bar code

PROPIEDADES DE PRODUCTO
PRODUCT PROPERTIES



4091

SILVER 

VÁLVULA ESFERA PN-25 M-H
PALANCA ERGONÓMICA
COLOR AZUL EN ACERO AL
CARBONO CON RECUBRI-
MIENTO ANTICORROSIÓN
M-F BRASS BALL VALVE PN-25
BLUE ERGONOMIC CARBON
STEEL HANDLE WITH ANTI-
CORROSION COATING



ACS
PZH

CÓDIGO	MEDIDA			€
CODE	SIZE			€
4091-015	1/2"	54	9	4,96
4091-020	3/4"	42	7	6,84
4091-025	1"	24	6	10,74
4091-032	1 1/4"	16	4	18,62
4091-040	1 1/2"	8	2	25,66
4091-050	2"	12	2	37,76



40912

SILVER 

VÁLVULA ESFERA PN-25 M-H
PALANCA ERGONÓMICA
COLOR ROJO EN ACERO AL
CARBONO CON RECUBRI-
MIENTO ANTICORROSIÓN
M-F BRASS BALL VALVE PN-25
RED ERGONOMIC CARBON
STEEL HANDLE WITH ANTI-
CORROSION COATING



ACS
PZH

CÓDIGO	MEDIDA			€
CODE	SIZE			€
40912-015	1/2"	54	9	4,96
40912-020	3/4"	42	7	6,84
40912-025	1"	24	6	10,74
40912-032	1 1/4"	16	4	18,62
40912-040	1 1/2"	8	2	25,66
40912-050	2"	12	2	37,76



4092

SILVER 

VÁLVULA ESFERA PN-25 H-H
PALANCA ERGONÓMICA
COLOR AZUL EN ACERO AL
CARBONO CON RECUBRI-
MIENTO ANTICORROSIÓN
F-F BRASS BALL VALVE PN-25
BLUE ERGONOMIC CARBON
STEEL HANDLE WITH ANTI-
CORROSION COATING



ACS
PZH

CÓDIGO	MEDIDA			€
CODE	SIZE			€
4092-015	1/2"	54	9	4,62
4092-020	3/4"	42	7	6,38
4092-025	1"	24	6	10,04
4092-032	1 1/4"	16	4	17,40
4092-040	1 1/2"	8	2	23,98
4092-050	2"	12	2	35,30
4092-065*	2 1/2"	12	1	77,72
4092-080*	3"	6	1	112,02
4092-100*	4"	4	1	187,78

* Próximamente disponible en palanca con recubrimien-
to anticorrosión Coming soon in handle with anticorro-
sion coating

- Recambio maneta disponible
Spare part handle available



40922

SILVER 

VÁLVULA ESFERA PN-25 H-H
PALANCA ERGONÓMICA
COLOR ROJO EN ACERO AL
CARBONO CON RECUBRI-
MIENTO ANTICORROSIÓN
F-F BRASS BALL VALVE PN-25
RED ERGONOMIC CARBON
STEEL HANDLE WITH ANTI-
CORROSION COATING



ACS
PZH

CÓDIGO	MEDIDA			€
CODE	SIZE			€
40922-015	1/2"	54	9	4,62
40922-020	3/4"	42	7	6,38
40922-025	1"	24	6	10,04
40922-032	1 1/4"	16	4	17,40
40922-040	1 1/2"	8	2	23,98
40922-050	2"	12	2	35,30
40922-065*	2 1/2"	12	1	77,72
40922-080*	3"	6	1	112,02
40922-100*	4"	4	1	187,78

* Próximamente disponible en palanca con recubrimien-
to anticorrosión Coming soon in handle with anticorro-
sion coating

- Recambio maneta disponible
Spare part handle available

4093

SILVER



VÁLVULA ESFERA PN-25 H-H
MANDO PALOMILLA COLOR
AZUL
F-F BALL VALVE PN-25 WITH
BLUE BUTTERFLY HANDLE



ACS

PZH

CÓDIGO	MEDIDA			€
CODE	SIZE			€
4093-015	1/2"	60	10	4,67
4093-020	3/4"	48	8	6,78
4093-025	1"	24	6	10,70

40932

SILVER



VÁLVULA ESFERA PN-25 H-H
MANDO PALOMILLA COLOR
ROJO
F-F BALL VALVE PN-25 WITH
RED BUTTERFLY HANDLE



ACS

PZH

CÓDIGO	MEDIDA			€
CODE	SIZE			€
40932-015	1/2"	60	10	4,67
40932-020	3/4"	48	8	6,78
40932-025	1"	24	6	10,70

4094

SILVER



VÁLVULA ESFERA PN-25 M-H
MANDO PALOMILLA COLOR
AZUL
M-F BALL VALVE PN-25 WITH
BLUE BUTTERFLY HANDLE



ACS

PZH

CÓDIGO	MEDIDA			€
CODE	SIZE			€
4094-015	1/2"	60	10	5,24
4094-020	3/4"	48	8	7,06
4094-025	1"	24	6	10,92

40942

SILVER



VÁLVULA ESFERA PN-25 M-H
MANDO PALOMILLA COLOR
ROJO
M-F BALL VALVE PN-25 WITH
RED BUTTERFLY HANDLE



ACS

PZH



CÓDIGO	MEDIDA			€
CODE	SIZE			€
40942-015	1/2"	60	10	5,24
40942-020	3/4"	48	8	7,06
40942-025	1"	24	6	10,92

492550

SILVER **R**

RECAMBIO - MANETA COLOR AZUL PARA VÁLVULA PN-25
SPARE PART - BLUE HANDLE FOR PN-25 BALL VALVE





CÓDIGO CODE	MEDIDA SIZE			€ €
	1/4"	180	30	
	3/8"	180	30	
492550-0820	1/2"	180	30	1,04
	3/4"	180	30	
492550-0025	1"	140	35	1,59
492550-0032	1 1/4"	80	20	2,17
492550-0040	1 1/2"	80	20	3,02
492550-0050	2"	120	20	3,76

492552

SILVER **R**

RECAMBIO - MANETA COLOR ROJO PARA VÁLVULA PN-25
SPARE PART - RED HANDLE FOR PN-25 BALL VALVE



CÓDIGO CODE	MEDIDA SIZE			€ €
	1/4"	180	30	
	3/8"	180	30	
492552-0820	1/2"	180	30	1,04
	3/4"	180	30	
492552-0025	1"	140	35	1,59
492552-0032	1 1/4"	80	20	2,17
492552-0040	1 1/2"	80	20	3,02
492552-0050	2"	120	20	3,76

MATERIALES:

Cuerpo latón cromado CW617N según UNE-EN-12165

COMPONENTS:

Body chrome plated brass CW617N according EN-12165

SERIES

PLATINUM

GOLD

SILVER

GRIFOS

BIBCOCK RANGE



CARACTERÍSTICAS:

Roscas según ISO 228/1 (DIN259)

FEATURES:

Threads according to ISO 228/1 (DIN259)



Palanca ergonómica
Ergonomic handle

Sistema antihielo
Nofrost system

Presión nominal:
16 Bar
Nominal pressure:
16 Bar

Límites de temperatura:
de -20 °C a 90 °C
Temperature limit from
-20 °C to 90 °C

Conexiones
a roscas
de ½", ¾" y 1"
Threads
connections
of ½", ¾" and 1"

LEYENDA DE ICONOS

ICON KEY

Posibles codificaciones
aplicadas en esta sección.

Possible encodings applied
in this section.



Antihielo
Nofrost
system



Inoxidable
Stainless steel



Código de
barras EAN
EAN bar code



Cierre de
Seguridad
Locking Device

PROPIEDADES DE PRODUCTO

PRODUCT PROPERTIES

4125

PLATINUM



GRIFO ESFERA JARDÍN PESADO PN-16 PALANCA ACERO INOXIDABLE COLOR NEGRO CON RACOR MANGUERA HEAVY BRASS BALL BIBCOCK GARDEN PN-16 WITH STAINLESS STEEL BLACK HANDLE AND HOSE CONNECTOR

ANTIHIELO NOFROST



CÓDIGO	MEDIDA			€
CODE	SIZE			€
4125-01520	1/2" x 3/4"	36	9	9,16
4125-02025	3/4" x 1"	16	4	11,17
4125-02532	1" x 1 1/4"	12	3	14,78

4111

GOLD



GRIFO ESFERA JARDÍN PN-16 RACOR MANGUERA BRASS BALL BIBCOCK GARDEN PN-16 HOSE CONNECTOR

ANTIHIELO NOFROST



CÓDIGO	MEDIDA			€
CODE	SIZE			€
4111-01520	1/2" x 3/4"	36	9	6,12
4111-02020	3/4" x 3/4"	32	8	8,45
4111-02025	3/4" x 1"	24	6	9,39
4111-02532	1" x 1 1/4"	12	3	12,21

4142

GOLD



GRIFO ESFERA JARDÍN PN-16 ENCHUFE RÁPIDO BRASS BALL BIBCOCK GARDEN PN-16 QUICK FEMALE CONNECTOR

ANTIHIELO NOFROST



CÓDIGO	MEDIDA			€
CODE	SIZE			€
4142-01520	1/2" x 3/4"	36	9	6,65
4142-02025	3/4" x 1"	24	6	10,50
4142-02532	1" x 1 1/4"	12	3	12,46

4144

GOLD



GRIFO ESFERA JARDÍN PN-16 CON PALANCA DE ACERO INOXIDABLE CON RACOR MANGUERA BRASS BALL BIBCOCK GARDEN PN-16 WITH STAINLESS STEEL HANDLE AND HOSE CONNECTOR

ANTIHIELO NOFROST



CÓDIGO	MEDIDA			€
CODE	SIZE			€
4144-01520	1/2" x 3/4"	36	9	8,49
4144-02025	3/4" x 1"	24	6	10,21
4144-02532	1" x 1 1/4"	12	3	12,57

4123

GOLD [*] [] []

GRIFO ESFERA JARDÍN PN-16 PALANCA ACERO INOXIDABLE CO-
LOR NEGRO Y ENCHUFE RÁPIDO BRASS BALL BIBCOCK GARDEN
PN-16 STAINLESS STEEL BLACK HANDLE AND QUICK FEMALE
CONNECTOR

**ANTIHIELO
NOFROST**



CÓDIGO	MEDIDA			€
CODE	SIZE			€
4123-01520	1/2" x 3/4"	36	9	8,57
4123-02025	3/4" x 1"	24	6	10,47
4123-02532	1" x 1 1/4"	12	3	12,61

4147

GOLD [] [*] [] []

GRIFO ESFERA JARDÍN PN-16 PALANCA CROMADA CON CIERRE
DE SEGURIDAD Y RACOR MANGUERA BRASS BALL BIBCOCK
GARDEN PN-16 CHROME HANDLE WITH LOCKING DEVICE AND
HOSE CONNECTOR

**ANTIHIELO
NOFROST**



CÓDIGO	MEDIDA			€
CODE	SIZE			€
4147-01520	1/2" x 3/4"	40	10	6,30
4147-02025	3/4" x 1"	24	6	9,52
4147-02532	1" x 1 1/4"	12	3	12,29

- Candado no incluido
Lock not included

4146

SILVER [] [] []

GRIFO ESFERA JARDÍN PN-16 CON RACOR MANGUERA MODELO
EXPORT BRASS BALL BIBCOCK GARDEN PN-16 WITH HOSE
CONNECTOR EXPORT TYPE



CÓDIGO	MEDIDA			€
CODE	SIZE			€
4146-01520	1/2" x 3/4"	36	9	5,33
4146-02020	3/4" x 3/4"	32	8	7,17
4146-02025	3/4" x 1"	24	6	7,56

4143

SILVER [] [] []

GRIFO ESFERA JARDÍN PN-16 CON ENCHUFE RÁPIDO MODELO
EXPORT BRASS BALL BIBCOCK GARDEN PN-16 WITH QUICK
FEMALE CONNECTOR EXPORT TYPE



CÓDIGO	MEDIDA			€
CODE	SIZE			€
4143-01520	1/2" x 3/4"	36	9	5,88
4143-02025	3/4" x 1"	24	6	8,77

4145



GRIFO JARDÍN DE LATÓN PN-10 ENCHUFE MANGUERA
BRASS BIBCOCK GARDEN PN-10 HOSE CONNECTOR



CÓDIGO	MEDIDA			€
CODE	SIZE			€
4145-01520	1/2" x 3/4"	40	10	10,47
4145-02020	3/4" x 3/4"	24	6	14,08
4145-02025	3/4" x 1"	24	6	15,40

4148



GRIFO ESFERA JARDÍN PN-16 DOS SALIDAS PALANCA CROMADA Y ENCHUFE RÁPIDO
BRASS BALL BIBCOCK GARDEN TWO OUTLETS PN-16 CHROME HANDLE WITH QUICK FEMALE



CÓDIGO	MEDIDA			€
CODE	SIZE			€
4148-0152020	1/2" x 3/4" x 3/4"	32	8	11,17

4149



VÁLVULA ESFERA PN-16 BARRIL PALANCA ALUMINIO
BARRELL BALL VALVE WITH ALUMINIUM HANDLE PN-16



CÓDIGO	MEDIDA			€
CODE	SIZE			€
4149-010	3/8"	40	10	5,73
4149-015	1/2"	40	10	5,89
4149-020	3/4"	24	6	7,35
4149-025	1"	16	4	16,05

4141



VÁLVULA ESFERA PN-16 BARRIL PALOMILLA
BARRELL BALL VALVE PN-16



CÓDIGO	MEDIDA			€
CODE	SIZE			€
4141-01515	1/2" x 1/2"	42	2	5,95
4141-02020	3/4" x 3/4"	30	2	7,50

4122



RACOR MANGUERA HEMBRA
TAP FEMALE HOSE CONNECTOR



CÓDIGO	MEDIDA			€
CODE	SIZE			€
4122-020	3/4"	320	80	1,18
4122-025	1"	200	50	1,43
4122-032	1 1/4"	100	25	1,73

4121



RACOR HEMBRA ENCHUFE RÁPIDO
QUICK FEMALE CONNECTOR



CÓDIGO	MEDIDA			€
CODE	SIZE			€
4121-020	3/4"	320	80	1,68
4121-025	1"	200	50	2,57
4121-032	1 1/4"	100	25	3,81

0921



GRIFO ESFERA JARDÍN INOXIDABLE PN-16 CON RACOR
MANGUERA STAINLESS STEEL BIB COCK GARDEN PN-16 HOSE
CONNECTOR

INOX



CÓDIGO	MEDIDA			€
CODE	SIZE			€
0921-015	1/2" x 3/4"	30	15	Consultar
0921-020	3/4" x 3/4"	20	10	Consultar
0921-025	1" x 1"	10	5	Consultar

- Condiciones válvulas acero inoxidable catálogo industrial
Conditions stainless steel valves industrial catalog

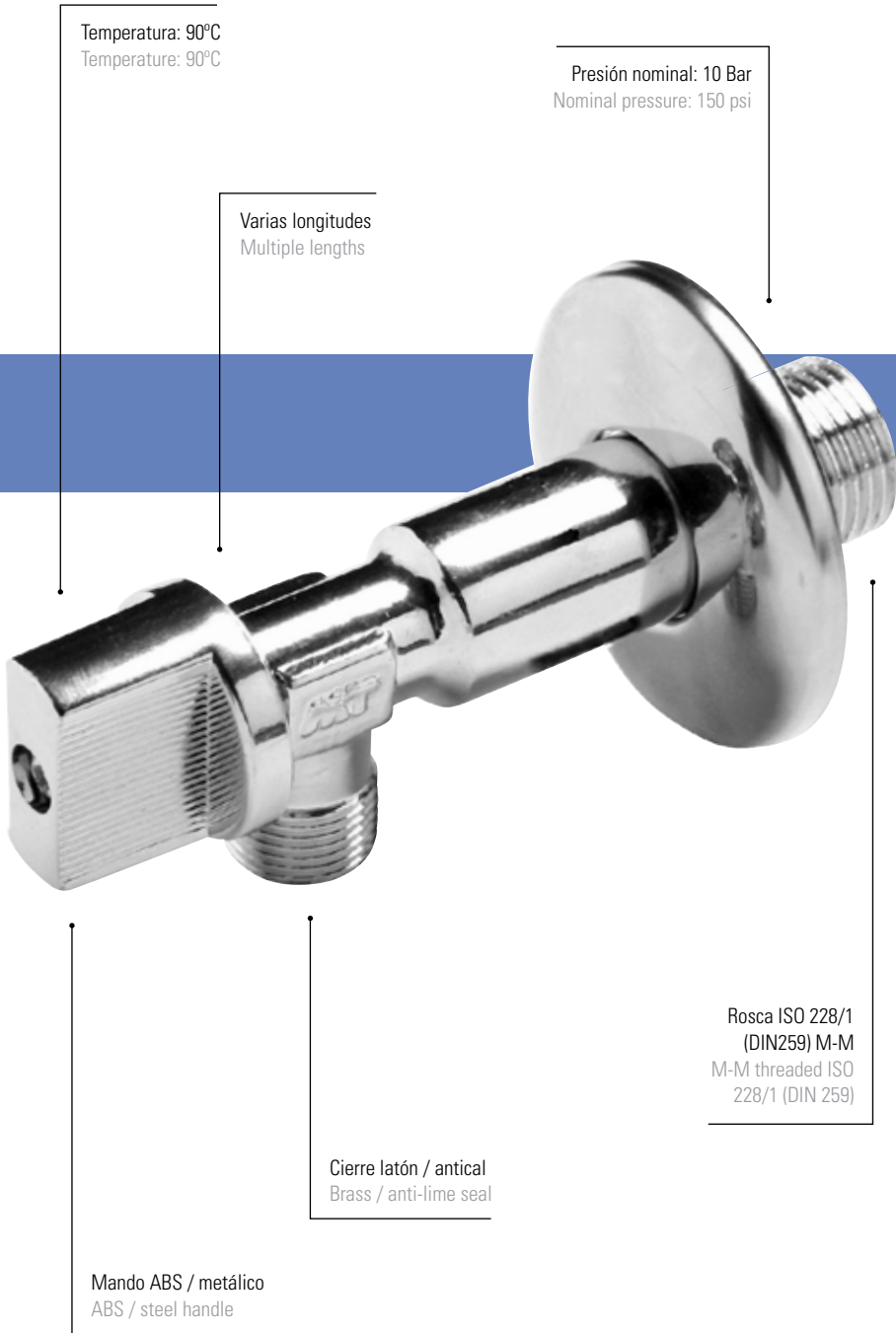

Temperatura: 90°C
Temperature: 90°C

Presión nominal: 10 Bar
Nominal pressure: 150 psi

Varias longitudes
Multiple lengths

Rosca ISO 228/1
(DIN259) M-M
M-M threaded ISO
228/1 (DIN 259)

Cierre latón / antical
Brass / anti-lime seal

Mando ABS / metálico
ABS / steel handle

VÁLVULAS DE ESCUADRA

ANGLE VALVES



MATERIALES:

Cuerpo latón cromado según CW617N
UNE-EN-12165
Rosca ISO 228/1 (DIN 259) M/M
Florón y filtro de acero inoxidable.

CARACTERÍSTICAS:

Empaquetadura de eje
Cierre rápido (¼ de vuelta)
Mecanismo de cierre latón CW614N UNE-EN-12165
Mecanismo de cierre plástico para escuadras antical.
Cierre esférico.

COMPONENTS:

Body chromed plated brass according CW617N
UNE-EN-12165
Threaded ISO 228/1 (DIN 259) M/M
Stainless steel cover plate and strainer.

FEATURES:

Packing gland in the stem
Fast close (¼ turn)
Open and close device made in brass CW614N UNE-EN-12165
Open and close device made in plastic for anti-lime square valves.
Spherical locking.

LEYENDA DE ICONOS ICON KEY

Posibles codificaciones aplicadas en esta sección.

Possible encodings applied in this section.



Código de barras EAN
EAN bar code

PROPIEDADES DE PRODUCTO
PRODUCT PROPERTIES

4404



VÁLVULA ESCUADRA CON FILTRO
ANGLE BALL VALVE WITH FILTER



CÓDIGO	MEDIDA			€
CODE	SIZE			€
4404-01510	1/2" x 3/8"	60	15	4,13
4404-01515	1/2" x 1/2"	60	15	4,27

- Longitud 58,5mm.
Length 58,5mm.

4405



VÁLVULA ESCUADRA LARGA CON FILTRO
LONG ANGLE VALVE WITH FILTER



CÓDIGO	MEDIDA			€
CODE	SIZE			€
4405-01510	1/2" x 3/8"	60	15	5,36
4405-01520	1/2" x 3/4"	60	15	6,74

- Longitud 72mm.
Length 72mm.

4411



VÁLVULA ESCUADRA MODELO EXPORT
ANGLE BALL VALVE MODEL EXPORT



CÓDIGO	MEDIDA			€
CODE	SIZE			€
4411-01510	1/2" x 3/8"	60	15	3,09
4411-01515	1/2" x 1/2"	60	15	3,21

- Longitud 73,5mm.
Length 73,5mm.

4402



VÁLVULA ESCUADRA
ANGLE VALVE



CÓDIGO	MEDIDA			€
CODE	SIZE			€
4402-01510	1/2" x 3/8"	60	15	3,37
4402-01515	1/2" x 1/2"	60	15	3,49
4402-01520	1/2" x 3/4"	60	15	4,38

- Longitud 79,5mm
Length 79,5mm.

4422

ANTI CAL / LIME



VÁLVULA ESCUADRA ANTICAL CON MANDO METÁLICO
ANTI-LIME ANGLE VALVE WITH METAL HANDLE



CÓDIGO	MEDIDA			€
CODE	SIZE			€
4422-01510	1/2" x 3/8"	60	15	4,11

- Longitud 79,5mm.
Length 79,5mm.

4406



VÁLVULA ESCUADRA LARGA
LONG ANGLE VALVE



CÓDIGO	MEDIDA			€
CODE	SIZE			€
4406-01510	1/2" x 3/8"	60	15	3,86

- Longitud 95mm.
Length 95mm.

4426

ANTI CAL / LIME



VÁLVULA ESCUADRA LARGA ANTICAL CON MANDO METÁLICO
ANTI-LIME LONG ANGLE VALVE WITH METAL HANDLE



CÓDIGO	MEDIDA			€
CODE	SIZE			€
4426-01510	1/2" x 3/8"	60	15	4,77

- Longitud 95mm.
Length 95mm.

4409



VÁLVULA DE ESCUADRA MODELO "DECO"
CON MANDO REDONDO
ANGLE VALVE "DECO" TYPE ROUND HANDLE



CÓDIGO	MEDIDA			€
CODE	SIZE			€
4409-01510	1/2" x 3/8"	45	1	10,59
4409-01515	1/2" x 1/2"	45	1	10,70

- Cierre cerámico antical
Anti-lime ceramic seal

4410



VÁLVULA DE ESCUADRA MODELO "DECO"
CON MANDO CUADRADO
ANGLE VALVE 'DECO' TYPE SQUARE HANDLE



CÓDIGO	MEDIDA			€
CODE	SIZE			€
4410-01510	1/2" x 3/8"	45	1	11,72
4410-01515	1/2" x 1/2"	45	1	11,88

- Cierre cerámico antical
Anti-lime ceramic seal

4400



GRIFO LAVADORA
WASHING MACHINE VALVE



CÓDIGO	MEDIDA			€
CODE	SIZE			€
4400-01520	1/2" x 3/4"	60	15	4,23

4401



GRIFO LAVADORA TIPO "M"
WASHING MACHINE VALVE 'M' TYPE



CÓDIGO	MEDIDA			€
CODE	SIZE			€
4401-01520	1/2" x 3/4"	48	12	4,40

- Longitud 82mm.
Length 82mm.

4434



GRIFO LAVADORA SIMPLE CON MANDO METÁLICO
SIMPLE WASHING MACHINE VALVE WITH METALIC HANDLE



CÓDIGO	MEDIDA			€
CODE	SIZE			€
4434-01520	1/2" x 3/4"	32	8	12,02

4435



GRIFO LAVADORA DOBLE CON MANDO METÁLICO
DOUBLE WASHING MACHINE VALVE WITH METALIC HANDLE



CÓDIGO	MEDIDA			€
CODE	SIZE			€
4435-0152020	1/2" x 3/4" x 3/4"	20	1	22,12

4407



VÁLVULA MIXTA LAVADORA LAVABO
WASHING MACHINE WASHBASIN MIXED VALVE



CÓDIGO	MEDIDA			€
CODE	SIZE			€
4407-01520	1/2" x 3/4" x 3/8"	28	7	11,30

LÍMITES TÉCNICOS:

Límites de temperatura:
de -20 °C a 100 °C
Presión nominal:
16 Bar (250 psi)

APLICACIONES

Garantizadas para el uso en
instalaciones en agua fría,
caliente y aire comprimido.

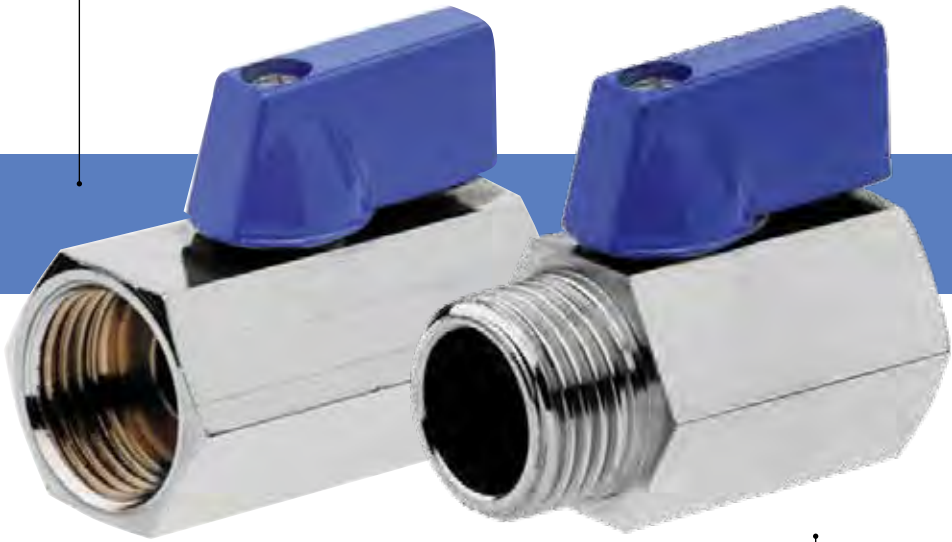
**TECHNICAL LIMITS:**

Temperature limit from
-20 °C to 100 °C
Nominal pressure:
16 Bar (250 psi)

APPLICATIONS

Guaranteed to be used in
the following installations:
Cold water, hot water and
compressed air.

OTRAS VÁLVULAS

OTHER VALVES



LEYENDA DE ICONOS ICON KEY

Posibles codificaciones
aplicadas en esta sección.

Possible encodings applied
in this section.



CERTIFICADOS DE PRODUCTO
PRODUCT CERTIFICATES



Inoxidable Código de barras EAN Recambios
Stainless steel EAN bar code Spare parts

PROPIEDADES DE PRODUCTO
PRODUCT PROPERTIES

4107



VÁLVULA ESFERA SOLDAR PN-30 PALANCA EN ACERO CROMADO
SOLDER END BALL VALVE PN-30 WITH CHROMED STEEL HANDLE



CÓDIGO	MEDIDA			€
CODE	SIZE			€
4107-015	15	48	8	5,60
4107-018	18	48	8	5,82
4107-022	22	36	6	8,74
4107-028	28	16	4	13,01
4107-035	35	12	2	22,44
4107-042	42	12	2	33,40
4107-054*	54	6	1	44,36

- * Disponible hasta agotar existencias
* While stocks lasts

4108



VÁLVULA ESFERA SOLDAR PN-30 MANDO PALOMILLA
SOLDER END BALL VALVE PN-30 BUTTERFLY HANDLE



CÓDIGO	MEDIDA			€
CODE	SIZE			€
4108-015	15	54	9	5,38
4108-018	18	54	9	5,55
4108-022	22	42	7	8,28
4108-028	28	20	5	13,13

4109



VÁLVULA ESFERA MINI PN-16 H-H
MANDO METÁLICO COLOR ROJO
F-F MINI BALL VALVE PN-16 RED
COLOR METAL HANDLE



CÓDIGO	MEDIDA			€
CODE	SIZE			€
4109-008	1/4"	144	24	4,19
4109-010	3/8"	144	24	4,19
4109-015	1/2"	108	18	4,43

4110



VÁLVULA ESFERA MINI PN-16 M-H
MANDO METÁLICO COLOR ROJO
M-F MINI BALL VALVE PN-16 RED
COLOR METAL HANDLE



CÓDIGO	MEDIDA			€
CODE	SIZE			€
4110-008	1/4"	144	24	4,19
4110-010	3/8"	144	24	4,19
4110-015	1/2"	108	18	4,43
4110-020	3/4"	78	13	9,73

41092



VÁLVULA ESFERA MINI PN-16 H-H
MANDO METÁLICO COLOR AZUL
F-F MINI BALL VALVE PN-16 BLUE
COLOR METAL HANDLE



CÓDIGO	MEDIDA			€
CODE	SIZE			€
41092-008	1/4"	144	24	4,19
41092-010	3/8"	144	24	4,19
41092-015	1/2"	108	18	4,43

- Disponible en acero inoxidable (Ref. 0914)
Available in stainless steel (Ref. 0914)

41102



VÁLVULA ESFERA MINI PN-16 M-H
MANDO METÁLICO COLOR AZUL
M-F MINI BALL VALVE PN-16 BLUE
COLOR METAL HANDLE



CÓDIGO	MEDIDA			€
CODE	SIZE			€
41102-008	1/4"	144	24	4,19
41102-010	3/8"	144	24	4,19
41102-015	1/2"	108	18	4,43

- Disponible en acero inoxidable (Ref. 0915)
Available in stainless steel (Ref. 0915)

4113



VÁLVULA DE COMPUERTA PASO ESTANDAR H-H
F-F GATE VALVE STANDARD FLOW



CÓDIGO	MEDIDA			€
CODE	SIZE			€
4113-015*	1/2"	48	12	5,07
4113-020*	3/4"	48	12	6,51
4113-025*	1"	32	8	8,75
4113-032*	1 1/4"	24	4	13,53
4113-040*	1 1/2"	12	3	19,93
4113-050*	2"	8	2	30,85
4113-065	2 1/2"	4	1	58,53
4113-080	3"	4	1	72,59
4113-100	4"	4	1	136,94

PN-16*/10**

4113CE



VÁLVULA COMPUERTA CIERRE ELÁSTICO H-H PASO ESTANDAR
F-F GATE VALVE WITH RUBBER WEDGE STANDARD FLOW



CÓDIGO	MEDIDA			€
CODE	SIZE			€
4113-015CE*	1/2"	48	12	8,22
4113-020CE*	3/4"	30	5	10,83
4113-025CE*	1"	16	4	15,94
4113-032CE	1 1/4"	8	2	25,57
4113-040CE	1 1/2"	8	2	31,96
4113-050CE	2"	6	1	50,17

- Compuerta NBR apta para hidrocarburos PN-16*/10**
NBR wedge suitable for hydrocarbons

4113I



VÁLVULA DE COMPUERTA PASO TOTAL H-H PN-16
F-F GATE VALVE FULL BORE PN-16



CÓDIGO	MEDIDA			€
CODE	SIZE			€
4113-015I	1/2"	48	12	6,29
4113-020I	3/4"	40	10	8,34
4113-025I	1"	24	6	12,36
4113-032I	1 1/4"	12	3	19,62
4113-040I	1 1/2"	8	2	26,78
4113-050I	2"	6	1	42,24
4113-065I	2 1/2"	4	1	62,12
4113-080I	3"	4	1	87,21
4113-100I	4"	4	1	164,87

4114



VÁLVULA DE RETENCIÓN PESADA CON OBTURADOR METÁLICO H-H
F-F NON RETURN VALVE HEAVY TYPE WITH METAL SHUTTER



CÓDIGO	MEDIDA			€
CODE	SIZE			€
4114-015*	1/2"	90	15	6,36
4114-020*	3/4"	48	12	9,06
4114-025*	1"	36	9	13,91
4114-032**	1 1/4"	24	6	22,14
4114-040**	1 1/2"	8	2	28,98
4114-050**	2"	8	2	42,77
4114-065***	2 1/2"	6	1	90,37
4114-080***	3"	4	1	142,33
4114-100***	4"	3	1	212,59

- Apto para hidrocarburos cierre NBR PN-25*/16**/10***
NBR seal suitable for hydrocarbons

4115



VÁLVULA DE RETENCIÓN LIGERA
CON OBTURADOR PLÁSTICO H-H
F-F NON RETURN VALVE LIGHT
TYPE WITH PLASTIC SHUTTER



CÓDIGO	MEDIDA			€
CODE	SIZE			€
4115-015*	1/2"	120	20	4,44
4115-020*	3/4"	90	15	6,41
4115-025*	1"	48	8	9,01
4115-032**	1 1/4"	24	6	12,29
4115-040**	1 1/2"	16	4	17,13
4115-050**	2"	8	2	29,26

PN-16*/10**

4215



VÁLVULA DE RETENCIÓN LIGERA
CON OBTURADOR METÁLICO H-H
F-F NON RETURN VALVE LIGHT
TYPE WITH METAL SHUTTER



CÓDIGO	MEDIDA			€
CODE	SIZE			€
4215-015*	1/2"	144	24	4,77
4215-020*	3/4"	90	15	6,81
4215-025*	1"	44	11	10,15
4215-032**	1 1/4"	24	6	14,00
4215-040**	1 1/2"	20	5	19,89
4215-050**	2"	8	2	30,26
4215-065***	2 1/2"	8	1	65,71
4215-080***	3"	3	1	93,87
4215-100***	4"	2	1	146,32

PN-16*/10**/8***

4116



FILTRO VÁLVULA DE RETENCIÓN (4114-4115-4215)
FILTER FOR NON RETURN VALVE (4114-4115-4215)



CÓDIGO	MEDIDA			€
CODE	SIZE			€
4116-015	1/2"	224	56	0,72
4116-020	3/4"	152	38	0,93
4116-025	1"	80	20	1,40
4116-032	1 1/4"	36	9	1,55
4116-040	1 1/2"	24	6	2,42
4116-050	2"	16	4	2,67
4116-065	2 1/2"	12	1	4,67
4116-080	3"	8	1	5,80
4116-100	4"	6	1	7,63

4117



VÁLVULA DE PIE ROSCA HEMBRA
FOOT VALVE FEMALE THREAD



CÓDIGO	MEDIDA			€
CODE	SIZE			€
4117-015*	1/2"	80	20	4,83
4117-020*	3/4"	48	12	8,35
4117-025*	1"	40	10	11,56
4117-032**	1 1/4"	12	3	13,53
4117-040**	1 1/2"	12	3	19,19
4117-050**	2"	8	1	35,76
4117-065***	2 1/2"	4	1	45,75
4117-080***	3"	4	1	67,79
4117-100***	4"	2	1	102,54

PN-16*/10**/8***

4118



VÁLVULA DE FONDO ROSCA
HEMBRA PN-16
BOTTOM VALVE FEMALE
THREAD PN-16



CÓDIGO	MEDIDA			€
CODE	SIZE			€
4118-015	1/2"	60	15	5,07
4118-020	3/4"	48	12	6,96
4118-025	1"	48	12	10,28
4118-032	1 1/4"	20	5	13,71
4118-040	1 1/2"	12	3	18,78
4118-050	2"	8	2	30,93
4118-065	2 1/2"	8	1	42,27
4118-080	3"	4	1	60,12
4118-100	4"	2	1	166,22

- Apto para hidrocarburos junta NBR
NBR seal suitable for hydrocarbons

4119



VÁLVULA DE CLAPETA CIERRE
ELÁSTICO H-H
F-F RUBBER WASHER SWING
CHECK VALVE



CÓDIGO	MEDIDA			€
CODE	SIZE			€
4119-015*	1/2"	72	12	6,08
4119-020*	3/4"	60	10	9,78
4119-025*	1"	28	7	13,17
4119-032**	1 1/4"	20	5	20,23
4119-040**	1 1/2"	16	4	26,89
4119-050**	2"	10	1	41,23
4119-065***	2 1/2"	5	1	61,51
4119-080***	3"	3	1	99,72
4119-100***	4"	2	1	166,40

PN-16*/10**/8***

4120



FILTRO Y TAMIZ INOXIDABLE H-H PN-16
F-F Y STRAINER WITH STAINLESS STEEL SIEVE PN-16



CÓDIGO	MEDIDA			€
CODE	SIZE			€
4120-015	1/2"	96	24	4,68
4120-020	3/4"	48	12	6,68
4120-025	1"	36	9	10,83
4120-032	1 1/4"	16	4	19,08
4120-040	1 1/2"	12	2	24,97
4120-050	2"	9	1	43,29

- Disponible en acero inoxidable (Ref. 0913)
Available in stainless steel (Ref. 0913)

4120R



RECAMBIO - TAMIZ INOXIDABLE PARA FILTRO EN Y PARA 4120
SPARE PART - STAINLESS STEEL SIEVE FOR Y STRAINER 4120



CÓDIGO	MEDIDA			€
CODE	SIZE			€
4120-015R	1/2"	400	100	0,28
4120-020R	3/4"	200	50	0,47
4120-025R	1"	200	50	0,56
4120-032R	1 1/4"	96	24	0,91
4120-040R	1 1/2"	44	11	1,18
4120-050R	2"	24	6	2,32

4230



ALARGADERA PARA VÁLVULA "CARLA"
ELONGATION FOR 'CARLA' VALVES



CÓDIGO	MEDIDA			€
CODE	SIZE			€
4230-01	-	2000	100	2,58

- Lado del cuadradillo 8x8mm. en todas las dimensiones
Side of square 8x8mm. in all dimensions

4224



MANETA Y FLORÓN PARA "CARLA"
HANDLE LONG NECK VALVE M TYPE 'CARLA'



CÓDIGO	MEDIDA			€
CODE	SIZE			€
4224-01	M	32	8	5,08

- Maneta para lado del cuadradillo 8x8mm.
Handle for 8x8mm. side square

4225



MANDO REDONDO Y FLORÓN PARA "CARLA"
HANDLE LONG NECK VALVES R TYPE 'CARLA'



CÓDIGO	MEDIDA			€
CODE	SIZE			€
4225-01	R	32	8	5,32

- Maneta para lado del cuadradillo 8x8mm.
Handle for 8x8mm. side square

4226



MANDO OCULTO Y FLORÓN PARA "CARLA"
HANDLE LONG NECK VALVES 'O' TYPE 'CARLA'



CÓDIGO	MEDIDA			€
CODE	SIZE			€
4226-01	O	36	9	4,55

- Maneta para lado del cuadradillo 8x8mm.
Handle for 8x8mm. side square

4415



VÁLVULA DE SEGURIDAD DE MEMBRANA 3 BAR
DIAPHRAGM SAFETY VALVE 3 BAR



CÓDIGO	MEDIDA			€
CODE	SIZE			€
4415-015	1/2"	100	1	8,35
4415-020	3/4"	90	1	14,13

4416



VÁLVULA DE SEGURIDAD DE MEMBRANA 7 BAR
DIAPHRAGM SAFETY VALVE 7 BAR



CÓDIGO	MEDIDA			€
CODE	SIZE			€
4416-015	1/2"	100	1	8,33
4416-020	3/4"	90	1	14,13

4414



VÁLVULA DE SEGURIDAD PESADA CON PALANCA 8.5 BAR M-H
M-F SAFETY VALVE FOR HEATERS WITH HANDLE 8.5 BAR



CÓDIGO	MEDIDA			€
CODE	SIZE			€
4414-020	3/4"	100	1	11,15

4413



VÁLVULA DE SEGURIDAD CON PALANCA 8.5 BAR M-H
M-F SAFETY VALVE FOR HEATERS WITH HANDLE 8.5 BAR



CÓDIGO	MEDIDA			€
CODE	SIZE			€
4413-015	1/2"	150	1	5,54

4412



VÁLVULA DE SEGURIDAD 8.5 BAR M-H
M-F SAFETY VALVE FOR WATER HEATER 8.5 BAR



CÓDIGO	MEDIDA			€
CODE	SIZE			€
4412-015	1/2"	150	1	4,56
4412-020	3/4"	100	1	10,04

4419



VÁLVULA CLICK CLACK UNIVERSAL Ø 37mm.
BRASS WASTE FOR BASIN WITH CLICK-CLACK
UNIVERSAL Ø 37mm.



CÓDIGO	MEDIDA			€
CODE	SIZE			€
4419-032	1 1/4"	36	1	21,20

4417



VÁLVULA CLICK CLACK Ø 37mm.
BRASS WASTE FOR WASH BASIN WITH CLICK-CLACK Ø 37mm.



CÓDIGO	MEDIDA			€
CODE	SIZE			€
4417-032	1 1/4"	24	1	13,97

4418



VÁLVULA CLICK CLACK Ø 66mm.
BRASS WASTE FOR BASIN WITH CLICK-CLACK Ø 66mm.



CÓDIGO	MEDIDA			€
CODE	SIZE			€
4418-032	1 1/4"	24	1	15,76

449117



RECAMBIO - JUNTA TÓRICA PARA 4417, 4418 Y 4419
SPARE PART - O-RING FOR 4417, 4418 AND 4419



CÓDIGO	MEDIDA			€
CODE	SIZE			€
449117-037	1 1/4"	3000	1	0,18

449017



RECAMBIO - JUNTA SILICONA PARA 4417 Y 4418
SPARE PART - SILICONE GASKET FOR 4417 Y 4418



CÓDIGO	MEDIDA			€
CODE	SIZE			€
449017-032	1 1/4"	500	1	0,43

LEYENDA DE ICONOS
ICON KEY

Posibles codificaciones aplicadas en esta sección.

Possible encodings applied in this section.



CERTIFICADOS DE PRODUCTO
PRODUCT CERTIFICATES



Código de barras EAN
EAN bar code

PROPIEDADES DE PRODUCTO
PRODUCT PROPERTIES



CONEXIÓN FLEXIBLE

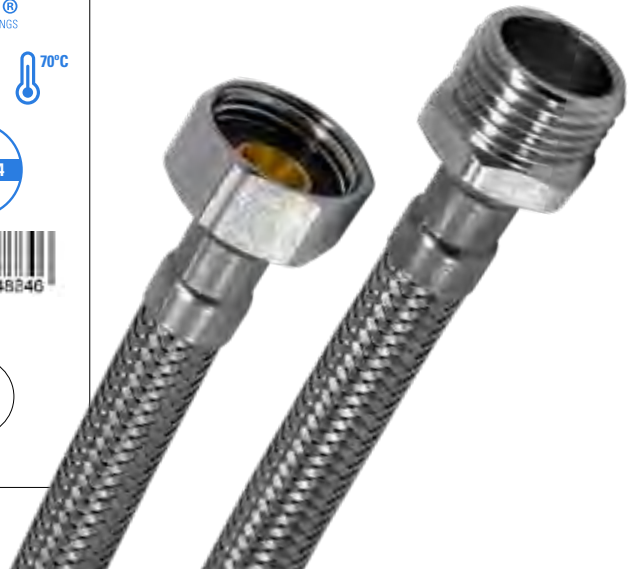
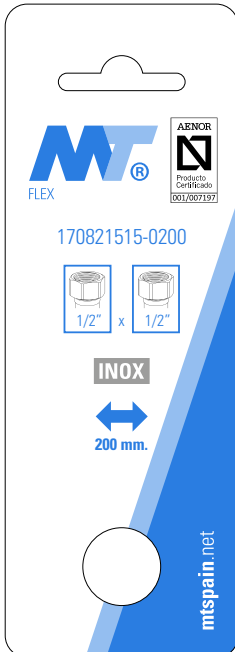

FLEXIBLE CONNECTION



170821010

CONEXIÓN FLEXIBLE "LATIGUILLO" DN8 H-H ACERO INOXIDABLE F-F FLEXIBLE DN8 STAINLESS STEEL CONNECTION





CÓDIGO	MEDIDA	LONGITUD				€
CODE	SIZE	LENGHT				€
170821010-0150	3/8" x 3/8"	150 mm.	200	10		1,82
170821010-0200	3/8" x 3/8"	200 mm.	100	10		1,93
170821010-0250	3/8" x 3/8"	250 mm.	100	10		1,93
170821010-0300	3/8" x 3/8"	300 mm.	100	10		2,11
170821010-0350	3/8" x 3/8"	350 mm.	100	10		2,16
170821010-0400	3/8" x 3/8"	400 mm.	120	10		2,51
170821010-0450	3/8" x 3/8"	450 mm.	100	10		2,57
170821010-0500	3/8" x 3/8"	500 mm.	100	10		2,64
170821010-0600	3/8" x 3/8"	600 mm.	100	10		3,05
170821010-0800	3/8" x 3/8"	800 mm.	100	10		3,57
170821010-1000	3/8" x 3/8"	1000 mm.	50	10		4,27

170821015

CONEXIÓN FLEXIBLE "LATIGUILLO" DN8 H-H ACERO INOXIDABLE F-F FLEXIBLE DN8 STAINLESS STEEL CONNECTION





CÓDIGO	MEDIDA	LONGITUD				€
CODE	SIZE	LENGHT				€
170821015-0150	3/8" x 1/2"	150 mm.	200	10		2,10
170821015-0200	3/8" X 1/2"	200 mm.	100	10		2,27
170821015-0250	3/8" x 1/2"	250 mm.	100	10		2,33
170821015-0300	3/8" x 1/2"	300 mm.	100	10		2,38
170821015-0350	3/8" x 1/2"	350 mm.	100	10		2,55
170821015-0400	3/8" X 1/2"	400 mm.	120	10		2,61
170821015-0500	3/8" x 1/2"	500 mm.	100	10		2,73
170821015-0600	3/8" X 1/2"	600 mm.	100	10		3,01
170821015-0800	3/8" X 1/2"	800 mm.	100	10		3,80
170821015-1000	3/8" x 1/2"	1000 mm.	50	10		4,26

170821515

CONEXIÓN FLEXIBLE "LATIGUILLO" DN8 H-H ACERO INOXIDABLE F-F FLEXIBLE DN8 STAINLESS STEEL CONNECTION



CÓDIGO	MEDIDA	LONGITUD				€
CODE	SIZE	LENGHT				€
170821515-0150	1/2" x 1/2"	150 mm.	200	10		2,10
170821515-0200	1/2" x 1/2"	200 mm.	100	10		2,27
170821515-0250	1/2" X 1/2"	250 mm.	100	10		2,33
170821515-0300	1/2" x 1/2"	300 mm.	100	10		2,38
170821515-0350	1/2" x 1/2"	350 mm.	100	10		2,55
170821515-0400	1/2" x 1/2"	400 mm.	120	10		2,61
170821515-0450	1/2" x 1/2"	450 mm.	100	10		2,67
170821515-0500	1/2" x 1/2"	500 mm.	100	10		2,73
170821515-0600	1/2" x 1/2"	600 mm.	100	10		3,01
170821515-0800	1/2" x 1/2"	800 mm.	100	10		3,80
170821515-1000	1/2" X 1/2"	1000 mm.	50	10		4,26

170811010

CONEXIÓN FLEXIBLE "LATIGUILLO" DN8 M-H ACERO INOXIDABLE M-F FLEXIBLE DN8 STAINLESS STEEL CONNECTION





CÓDIGO	MEDIDA	LONGITUD				€
CODE	SIZE	LENGHT				€
170811010-0150	3/8" x 3/8"	150 mm.	200	10		1,76
170811010-0200	3/8" x 3/8"	200 mm.	100	10		1,87
170811010-0250	3/8" x 3/8"	250 mm.	100	10		1,87
170811010-0300	3/8" x 3/8"	300 mm.	100	10		2,05
170811010-0350	3/8" x 3/8"	350 mm.	100	10		2,10
170811010-0400	3/8" x 3/8"	400 mm.	120	10		2,45
170811010-0500	3/8" x 3/8"	500 mm.	100	10		2,55
170811010-0600	3/8" x 3/8"	600 mm.	100	10		2,95
170811010-0800	3/8" x 3/8"	800 mm.	100	10		3,47
170811010-1000	3/8" x 3/8"	1000 mm.	50	10		4,14

170811015 **AENOR**

CONEXIÓN FLEXIBLE "LATIGUILLO" DN8 M-H ACERO
INOXIDABLE M-F FLEXIBLE DN8 STAINLESS STEEL CONNECTION





CÓDIGO	MEDIDA	LONGITUD			€
CODE	SIZE	LENGHT			€
170811015-0150	3/8" x 1/2"	150 mm.	200	10	2,17
170811015-0200	3/8" x 1/2"	200 mm.	100	10	2,27
170811015-0250	3/8" x 1/2"	250 mm.	100	10	2,33
170811015-0300	3/8" x 1/2"	300 mm.	100	10	2,42
170811015-0350	3/8" x 1/2"	350 mm.	100	10	2,55
170811015-0400	3/8" x 1/2"	400 mm.	120	10	2,61
170811015-0500	3/8" x 1/2"	500 mm.	100	10	2,74
170811015-0600	3/8" x 1/2"	600 mm.	100	10	3,01
170811015-0800	3/8" x 1/2"	800 mm.	100	10	3,80
170811015-1000	3/8" x 1/2"	1000 mm.	50	10	4,26

- Rosca macho 3/8" Male threaded 3/8"
- Rosca hembra 1/2" Female threaded 1/2"

170811510 **AENOR**

CONEXIÓN FLEXIBLE "LATIGUILLO" DN8 M-H ACERO
INOXIDABLE M-F FLEXIBLE DN8 STAINLESS STEEL CONNECTION





CÓDIGO	MEDIDA	LONGITUD			€
CODE	SIZE	LENGHT			€
170811510-0150	1/2" x 3/8"	150 mm.	200	10	2,17
170811510-0200	1/2" x 3/8"	200 mm.	100	10	2,27
170811510-0250	1/2" x 3/8"	250 mm.	100	10	2,33
170811510-0300	1/2" x 3/8"	300 mm.	100	10	2,42
170811510-0350	1/2" x 3/8"	350 mm.	100	10	2,55
170811510-0400	1/2" x 3/8"	400 mm.	120	10	2,61
170811510-0450	1/2" x 3/8"	450 mm.	100	10	2,67
170811510-0500	1/2" x 3/8"	500 mm.	100	10	2,74
170811510-0600	1/2" x 3/8"	600 mm.	100	10	3,01
170811510-0800	1/2" x 3/8"	800 mm.	100	10	3,80
170811510-1000	1/2" x 3/8"	1000 mm.	50	10	4,26

- Rosca macho 1/2" Male threaded 1/2"
- Rosca hembra 3/4" Female threaded 3/4"

170811515 **AENOR**

CONEXIÓN FLEXIBLE "LATIGUILLO" DN8 M-H ACERO
INOXIDABLE M-F FLEXIBLE DN8 STAINLESS STEEL CONNECTION



CÓDIGO	MEDIDA	LONGITUD			€
CODE	SIZE	LENGHT			€
170811515-0150	1/2" x 1/2"	150 mm.	200	10	2,17
170811515-0200	1/2" x 1/2"	200 mm.	100	10	2,27
170811515-0250	1/2" x 1/2"	250 mm.	100	10	2,33
170811515-0300	1/2" x 1/2"	300 mm.	100	10	2,42
170811515-0350	1/2" x 1/2"	350 mm.	100	10	2,55
170811515-0400	1/2" x 1/2"	400 mm.	120	10	2,61
170811515-0450	1/2" x 1/2"	450 mm.	100	10	2,67
170811515-0500	1/2" x 1/2"	500 mm.	100	10	2,74
170811515-0600	1/2" x 1/2"	600 mm.	100	10	3,01
170811515-0800	1/2" x 1/2"	800 mm.	100	10	3,80
170811515-1000	1/2" x 1/2"	1000 mm.	50	10	4,26

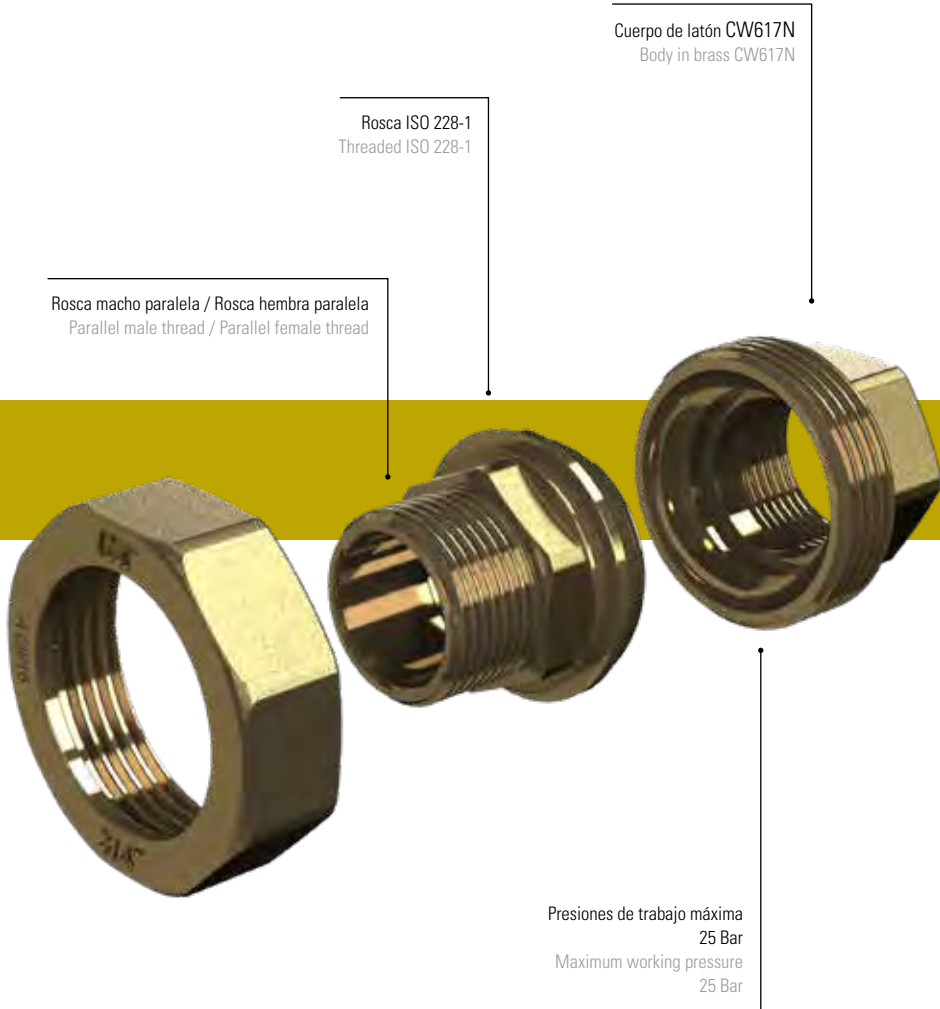

Rosca macho paralela / Rosca hembra paralela
Parallel male thread / Parallel female thread

Rosca ISO 228-1
Threaded ISO 228-1

Cuerpo de latón CW617N
Body in brass CW617N

Presiones de trabajo máxima
25 Bar
Maximum working pressure
25 Bar

SERIE 87 ACCESORIO DE LATÓN ROSCADO

BRASS THREADED FITTING

MATERIALES:

Cuerpo latón
¼" - 1" UNE-EN-12165
1 ¼" - 4" UNE-EN-12164

COMPONENTS:

Body in brass
¼" - 1" UNE-EN-12165
1 ¼" - 4" UNE-EN-12164

ROSCADO THREADED



MÉTODO DE FABRICACIÓN:

Estampado en caliente

PRODUCTION METHOD:

Hot forged

CARACTERÍSTICAS:

Fabricado de acuerdo a la norma EN 1254-1

FEATURES:

Manufactured according to standard EN 1254-1

LEYENDA DE ICONOS

ICON KEY

Posibles codificaciones aplicadas en esta sección.

Possible encodings applied in this section.



Código de barras EAN Recambios
EAN bar code Spare parts

PROPIEDADES DE PRODUCTO
PRODUCT PROPERTIES

87001



CURVA 90° M-H
M-F LONG SWEEP BEND 90°



CÓDIGO	MEDIDA			€
CODE	SIZE			€
87001-015	1/2"	120	10	5,30
87001-020	3/4"	70	10	7,71
87001-025	1"	40	5	12,86
87001-032	1 1/4"	20	5	21,16
87001-040	1 1/2"	10	5	29,40
87001-050	2"	17	1	48,53

- Rosca macho paralela
Parallel male thread

87002



CURVA 90° H-H
F-F LONG SWEEP BEND 90°



CÓDIGO	MEDIDA			€
CODE	SIZE			€
87002-015	1/2"	120	10	4,77
87002-020	3/4"	70	10	7,44
87002-025	1"	40	5	12,97
87002-032	1 1/4"	20	5	23,90
87002-040	1 1/2"	10	5	34,68
87002-050	2"	17	1	56,09

87090



CODO 90° H-H
F-F ELBOW 90°



CÓDIGO	MEDIDA			€
CODE	SIZE			€
87090-010	3/8"	340	10	2,55
87090-015	1/2"	180	10	2,90
87090-020	3/4"	110	10	4,50
87090-025	1"	60	5	7,14
87090-032	1 1/4"	35	5	11,59
87090-040	1 1/2"	30	5	16,12
87090-050	2"	36	1	25,78
87090-065	2 1/2"	16	1	56,74
87090-080	3"	12	1	74,78
87090-100	4"	4	1	137,26

87090R



CODO 90° REDUCIDO H-H
F-F REDUCING ELBOW 90°



CÓDIGO	MEDIDA			€
CODE	SIZE			€
87090-01510	1/2" x 3/8"	230	10	2,95
87090-02015	3/4" x 1/2"	130	10	4,78
87090-02515	1" x 1/2"	100	5	6,59
87090-02520	1" x 3/4"	75	5	6,80
87090-03225	1 1/4" x 1"	50	5	14,04
87090-04025	1 1/2" x 1"	40	5	16,05
87090-04032	1 1/2" x 1 1/4"	30	5	19,83

87092



CODO 90° M-H
M-F ELBOW 90°



CÓDIGO	MEDIDA			€
CODE	SIZE			€
87092-010	3/8"	280	10	2,93
87092-015	1/2"	200	10	3,11
87092-020	3/4"	100	10	4,65
87092-025	1"	60	5	7,61
87092-032	1 1/4"	35	5	12,18
87092-040	1 1/2"	25	5	16,77
87092-050	2"	32	1	25,90
87092-065	2 1/2"	17	1	64,67
87092-080	3"	12	1	75,86

- Rosca macho paralela
Parallel male thread

87093



CODO 90° M-M
M-M ELBOW 90°



NEW

CÓDIGO	MEDIDA			€
CODE	SIZE			€
87093-010	3/8"	480	10	1,90
87093-015	1/2"	240	10	2,35
87093-020	3/4"	120	10	3,62

- Rosca macho paralela
Parallel male thread

87098



CODO 90° M-H CON CONECTOR 2 PIEZAS
M-F ELBOW 90° WITH 2 PIECES CONNECTOR

NEW



CÓDIGO	MEDIDA			€
CODE	SIZE			€
87098-015	1/2"	100	10	6,00
87098-020	3/4"	60	10	9,63
87098-025	1"	30	5	15,74

- Rosca macho paralela
Parallel male thread

87130



TE IGUAL H
F EQUAL TEE



CÓDIGO	MEDIDA			€
CODE	SIZE			€
87130-010	3/8"	180	10	2,98
87130-015	1/2"	120	10	3,36
87130-020	3/4"	60	10	6,03
87130-025	1"	45	5	8,66
87130-032	1 1/4"	25	5	14,46
87130-040	1 1/2"	20	5	19,20
87130-050	2"	26	1	32,77
87130-065	2 1/2"	12	1	79,70
87130-080	3"	6	1	91,05
87130-100	4"	4	1	182,47

87130R



TE REDUCIDA H
F REDUCING TEE



CÓDIGO	MEDIDA			€
CODE	SIZE			€
87130-01510	1/2" x 3/8"	130	10	4,03
87130-02015	3/4" x 1/2"	90	10	5,09
87130-02515	1" x 1/2"	60	5	8,11
87130-02520	1" x 3/4"	50	5	9,71
87130-03215	1 1/4" x 1/2"	40	5	12,79
87130-03220	1 1/4" x 3/4"	30	5	14,23
87130-03225	1 1/4" x 1"	30	5	13,42
87130-04015	1 1/2" x 1/2"	25	5	16,13
87130-04020	1 1/2" x 3/4"	25	5	15,99
87130-04025	1 1/2" x 1"	25	5	17,56
87130-04032	1 1/2" x 1 1/4"	20	5	19,17
87130-05015	2" x 1/2"	42	1	23,22
87130-05020	2" x 3/4"	42	1	23,90
87130-05025	2" x 1"	42	1	25,68
87130-05032	2" x 1 1/4"	36	1	25,61

87180

CRUZ H
F CROSS



CÓDIGO	MEDIDA			€
CODE	SIZE			€
87180-010	3/8"	200	10	3,95
87180-015	1/2"	110	10	4,57
87180-020	3/4"	60	10	7,93
87180-025	1"	35	5	13,17
87180-032	1 1/4"	20	5	18,71
87180-040	1 1/2"	15	5	23,68
87180-050	2"	18	1	42,53

87132



TE IGUAL MACHO
M EQUAL TEE



CÓDIGO	MEDIDA			€
CODE	SIZE			€
87132-015	1/2"	200	10	2,47
87132-020	3/4"	90	10	4,59

- Rosca macho paralela
Parallel male thread

87240



MANGUITO REDUCCIÓN H-H
F-F REDUCING SOCKET





CÓDIGO	MEDIDA			€
CODE	SIZE			€
87240-01510	1/2" x 3/8"	300	10	1,68
87240-02010	3/4" x 3/8"	250	10	2,54
87240-02015	3/4" x 1/2"	210	10	2,77
87240-02515	1" x 1/2"	160	5	3,63
87240-02520	1" x 3/4"	150	5	4,00
87240-03225	1 1/4" x 1"	90	5	6,41
87240-04025	1 1/2" x 1"	70	5	7,64
87240-04032	1 1/2" x 1 1/4"	60	5	8,07
87240-05025	2" x 1"	76	1	11,61
87240-05032	2" x 1 1/4"	76	1	11,96
87240-05040	2" x 1 1/2"	76	1	12,48

87241



TUERCA REDUCCIÓN M-H
M-F REDUCING BUSHINGS



CÓDIGO CODE	MEDIDA SIZE			€ €
87241-01008*	3/8" x 1/4"	800	10	0,77
87241-01508*	1/2" x 1/4"	500	10	1,41
87241-01510*	1/2" x 3/8"	500	10	1,12
87241-02015*	3/4" x 1/2"	300	10	1,68
87241-02515*	1" x 1/2"	200	5	3,31
87241-02520*	1" x 3/4"	200	5	2,80
87241-03220*	1 1/4" x 3/4"	140	5	5,84
87241-03225*	1 1/4" x 1"	140	5	4,54
87241-04025**	1 1/2" x 1"	115	5	8,06
87241-04032**	1 1/2 x 1 1/4"	115	5	5,11
87241-05025**	2" x 1"	140	1	14,08
87241-05032**	2" x 1 1/4"	140	1	13,95
87241-05040**	2" x 1 1/2"	120	1	11,34
87241-06532**	2 1/2" x 1 1/4"	90	1	22,63
87241-06540**	2 1/2" x 1 1/2"	90	1	26,26
87241-06550**	2 1/2" x 2"	90	1	21,85
87241-08050**	3" x 2"	56	1	45,63
87241-08065**	3" x 2 1/2"	56	1	29,67
87241-10050**	4" x 2"	26	1	74,39
87241-10065**	4" x 2 1/2"	26	1	76,09
87241-10080**	4" x 3"	26	1	76,09



- * Hexagonal / Hexagonal
- ** Octogonal / Octagonal
- Rosca macho paralela
Parallel male thread

87245



MACHÓN REDUCIDO M-M
M-M REDUCING NIPPLE



CÓDIGO CODE	MEDIDA SIZE			€ €
87245-01008*	3/8" x 1/4"	600	10	1,27
87245-01508*	1/2" x 1/4"	400	10	1,34
87245-01510*	1/2" x 3/8"	500	10	1,50
87245-02015*	3/4" x 1/2"	270	10	2,15
87245-02515*	1" x 1/2"	160	5	3,03
87245-02520*	1" x 3/4"	150	5	3,16
87245-03220*	1 1/4" x 3/4"	100	5	5,05
87245-03225*	1 1/4" x 1"	95	5	5,53
87245-04025**	1 1/2" x 1"	80	5	7,74
87245-04032**	1 1/2" x 1 1/4"	70	5	7,96
87245-05025**	2" x 1"	120	1	9,94
87245-05032**	2" x 1 1/4"	120	1	9,91
87245-05040**	2" x 1 1/2"	96	1	11,58

- * Hexagonal / Hexagonal
- ** Octogonal / Octagonal
- Rosca macho paralela
Parallel male thread

87246



MANGUITO REDUCCIÓN M-H
M-F REDUCING NIPPLE SOCKET



CÓDIGO CODE	MEDIDA SIZE			€ €
87246-00810*	1/4" x 3/8"	500	10	1,53
87246-01008*	3/8" x 1/4"	750	10	1,45
87246-01015*	3/8" x 1/2"	400	10	1,84
87146-01020	3/8" x 3/4"	180	10	2,50
87246-01510*	1/2" x 3/8"	500	10	1,73
87246-01520*	1/2" x 3/4"	280	10	2,57
87246-01525*	1/2" x 1"	180	10	4,14
87246-02015*	3/4" x 1/2"	280	10	2,39
87246-02025*	3/4" x 1"	160	10	4,14
87246-02520*	1" x 3/4"	150	5	4,14
87246-02532**	1" x 1 1/4"	105	5	6,86
87246-02540**	1" x 1 1/2"	75	5	11,26
87246-02550**	1" x 2"	115	5	13,39
87246-03240**	1 1/4" x 1 1/2"	70	5	12,38
87246-03250**	1 1/4" x 2"	110	5	13,50
87246-04050**	1 1/2" x 2"	110	5	12,97

- * Hexagonal / Hexagonal
- ** Octogonal / Octagonal
- Rosca macho paralela
Parallel male thread

87271



MANGUITO ANTIELECTRÓLISIS H-H
F-F ANTI-ELECTROLYTIC SOCKET



CÓDIGO CODE	MEDIDA SIZE			€ €
87271-015	1/2"	250	25	3,06
87271-020	3/4"	200	15	4,81
87271-025	1"	100	10	7,47
87271-032	1 1/4"	45	1	17,16
87271-040	1 1/2"	30	1	35,90
87271-050	2"	20	1	50,80

87270



MANGUITO H-H
F-F SOCKET



CÓDIGO CODE	MEDIDA SIZE			€ €
87270-010	3/8"	400	10	1,55
87270-015	1/2"	230	10	2,17
87270-020	3/4"	140	10	3,24
87270-025	1"	100	10	5,13
87270-032	1 1/4"	55	5	7,02
87270-040	1 1/2"	35	5	11,09
87270-050	2"	45	1	16,65
87270-065	2 1/2"	30	1	32,98
87270-080	3"	21	1	49,61
87270-100	4"	12	1	88,36

87280



MACHÓN M-M
M-M HEXAGON NIPPLE



CÓDIGO CODE	MEDIDA SIZE			€ €
87280-008*	1/4"	800	10	0,96
87280-010*	3/8"	500	10	1,20
87280-015*	1/2"	300	10	1,63
87280-020*	3/4"	200	10	2,14
87280-025*	1"	120	5	3,24
87280-032*	1 1/4"	75	5	5,92
87280-040**	1 1/2"	60	5	8,06
87280-050**	2"	96	1	11,89
87280-065**	2 1/2"	45	1	32,29
87280-080**	3"	32	1	49,07
87280-100**	4"	12	1	89,83

- * Hexagonal / Hexagonal
- ** Octogonal / Octagonal
- Rosca macho paralela
Parallel male thread

87290



TAPÓN MACHO CON REBORDE
M PLUG BEADED



CÓDIGO CODE	MEDIDA SIZE			€ €
87290-008*	1/4"	900	10	1,02
87290-010*	3/8"	600	10	0,88
87290-015*	1/2"	470	10	1,19
87290-020*	3/4"	300	10	1,91
87290-025*	1"	200	5	2,84
87290-032*	1 1/4"	120	5	4,50
87290-040*	1 1/2"	110	5	6,59
87290-050*	2"	160	1	11,45
87290-065**	2 1/2"	84	1	27,27
87290-080**	3"	56	1	32,47
87290-100**	4"	24	1	54,19

- * Hexagonal / Hexagonal
- ** Octogonal / Octagonal
- Rosca macho paralela
Parallel male thread

87300



TAPÓN HEXAGONAL H
F HEXAGON CAP



CÓDIGO CODE	MEDIDA SIZE			€ €
87300-010*	3/8"	600	10	1,00
87300-015*	1/2"	430	10	1,34
87300-020*	3/4"	300	10	1,85
87300-025*	1"	200	5	2,91
87300-032**	1 1/4"	150	5	3,59
87300-040**	1 1/2"	110	5	4,86
87300-050**	2"	135	1	8,07

- * Hexagonal / Hexagonal
- ** Octogonal / Octagonal

87315



ENTRONQUE MANGUERA
HEXAGON HOSE NIPPLE



CÓDIGO CODE	MEDIDA SIZE			€ €
87315-00810	1/4" x 10	600	10	1,41
87315-00812	1/4" x 12	350	10	1,49
87315-01012	3/8" x 12	300	10	1,83
87315-01512	1/2" x 12	300	10	2,28
87315-01514	1/2" x 14	280	10	2,63
87315-01516	1/2" x 16	240	10	2,71
87315-01518	1/2" x 18	230	10	2,86
87315-01520	1/2" x 20	190	10	3,17
87315-02020	3/4" x 20	140	10	3,63
87315-02025	3/4" x 25	120	10	4,36
87315-02525	1" x 25	100	5	6,70
87315-02530	1" x 30	80	5	7,59
87315-03230	1 1/4" x 30	50	5	10,63
87315-03235	1 1/4" x 35	50	5	10,99
87315-03238	1 1/4" x 38	40	5	12,33
87315-03240	1 1/4" x 40	40	5	12,90
87315-04038	1 1/2" x 38	30	5	13,41
87315-04045	1 1/2" x 45	30	5	14,23
87315-04050	1 1/2" x 50	20	5	17,45
87315-05060	2" x 60	33	1	23,73

- Rosca macho paralela
Parallel male thread

87318



TE CINCO VÍAS
FIVE WAY TEE



CÓDIGO CODE	MEDIDA SIZE			€ €
87318-025	1"	30	5	13,14

- Rosca macho paralela
Parallel male thread

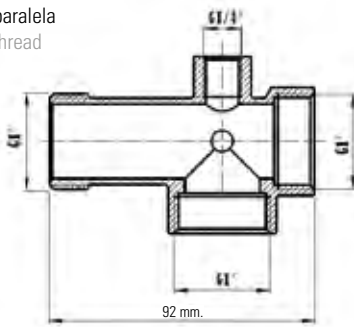

87341



TUERCA UNIÓN ASIENTO
CÓNICO M-H
M-F STRAIGHT UNION
TAPERED SEAT



CÓDIGO	MEDIDA			€
CODE	SIZE			€
87341-015*	1/2"	120	10	8,23
87341-020*	3/4"	70	10	11,92
87341-025*	1"	45	5	17,48
87341-032**	1 1/4"	30	5	27,37
87341-040**	1 1/2"	20	5	34,83
87341-050**	2"	24	1	54,05

- * Hexagonal / Hexagonal
- ** Octogonal / Octagonal
- Rosca macho paralela
Parallel male thread

873412



TUERCA UNIÓN TRES PIEZAS
LATÓN M-H ASIENTO CÓNICO
C/JUNTA
M-F THREE PIECES BRASS
STRAIGHT UNION TAPERED
SEAT WITH O-RING



CÓDIGO	MEDIDA			€
CODE	SIZE			€
873412-015	1/2"	130	10	8,23
873412-020	3/4"	80	10	11,92
873412-025	1"	50	5	17,48
873412-032	1 1/4"	30	5	27,37
873412-040	1 1/2"	20	5	34,83
873412-050	2"	12	1	54,05

- * Hexagonal / Hexagonal
- ** Octogonal / Octagonal
- Rosca macho paralela
Parallel male thread

87500



RACOR CODO MURAL H-H
F-F WALL PLATED ELBOW

NEW



CÓDIGO	MEDIDA			€
CODE	SIZE			€
87500-015	1/2"	140	10	3,20

87340



TUERCA UNIÓN ASIENTO
CÓNICO H-H
F-F STRAIGHT UNION TAPERED
SEAT



CÓDIGO	MEDIDA			€
CODE	SIZE			€
87340-015*	1/2"	140	10	7,96
87340-020*	3/4"	80	10	10,94
87340-025*	1"	60	5	14,68
87340-032**	1 1/4"	30	5	20,75
87340-040**	1 1/2"	25	5	33,81
87340-050**	2"	30	1	42,72

- * Hexagonal / Hexagonal
- ** Octogonal / Octagonal

87529



MANGUITO IGUAL M-H "TIPO MARSELLA"
M-F EQUAL SOCKET 'MARSELLA TYPE'



CÓDIGO	MEDIDA			€
CODE	SIZE			€
87529-008	1/4"	800	10	1,00
87529-010	3/8"	500	10	1,04
87529-015	1/2"	320	10	1,65
87529-020	3/4"	220	10	2,54
87529-025	1"	110	5	4,12
87529-032	1 1/4"	80	5	6,49
87529-040	1 1/2"	50	5	9,35
87529-050	2"	70	1	14,71

- Rosca macho paralela
Parallel male thread

87530



MANGUITO IGUAL M-H (HEXÁGONO INTERIOR)
M-F EQUAL SOCKET (HEXAGON INSIDE)



CÓDIGO	MEDIDA			€
CODE	SIZE			€
87530-1502	1/2" x 2 cm.	250	10	3,60

- Rosca macho paralela
Parallel male thread

87531



MANGUITO IGUAL M-H (HEXÁGONO INTERIOR)
M-F EQUAL SOCKET (HEXAGON INSIDE)



CÓDIGO	MEDIDA			€
CODE	SIZE			€
87531-015	1/2" x 1 cm.	220	10	2,45

- Rosca macho paralela
Parallel male thread

87533



ALARGADERA ACABADO LATÓN M-H (HEXÁGONO INTERIOR)
M-F EXTENSION FITTING BRASS FINISH (HEXAGON INSIDE)



CÓDIGO	MEDIDA			€
CODE	SIZE			€
87533-015020	1/2" x 20 mm.	300	10	2,78
87533-015030	1/2" x 30 mm.	200	10	3,69
87533-015050	1/2" x 50 mm.	130	5	5,55
87533-015100	1/2" x 100 mm.	90	5	10,14
87533-020050	3/4" x 50 mm.	90	5	7,12
87533-020100	3/4" x 100 mm.	60	5	13,34

- Rosca macho paralela
Parallel male thread

87532



MANGUITO IGUAL M-H
M-F EQUAL SOCKET



CÓDIGO	MEDIDA			€
CODE	SIZE			€
87532-01503	1/2" x 3 cm.	250	10	3,42

- Rosca macho paralela
Parallel male thread

87563



RACOR HEMBRA DOS PIEZAS MANGUERA H
FEMALE TWO PIECES HOSE NIPPLE



CÓDIGO	MEDIDA			€
CODE	SIZE			€
87563-01514	1/2" x 14	300	10	3,24
87563-02020	3/4" x 20	180	10	4,83
87563-02525	1" x 25	100	5	6,80
87563-03230	1 1/4" x 30	80	5	11,00
87563-03235	1 1/4" x 35	80	5	11,50
87563-04040	1 1/2" x 40	50	1	15,79

87575



ANILLO REDUCIDO M-H
REDUCING RING M-F



CÓDIGO	MEDIDA			€
CODE	SIZE			€
87575-01510	1/2" x 3/8"	450	10	2,04
87575-02015	3/4" x 1/2"	280	10	2,71

- Rosca macho paralela
Parallel male thread

87550



RACOR DEPÓSITO CON TUERCA CORREDERA
TANK OUTLET CONNECTION



CÓDIGO	MEDIDA			€
CODE	SIZE			€
87550-010	3/8"	180	10	3,37
87550-015	1/2"	120	10	4,28
87550-020	3/4"	80	10	5,80
87550-025	1"	50	5	8,70
87550-032	1 1/4"	30	5	12,06
87550-040	1 1/2"	25	1	18,68
87550-050	2"	30	1	29,25
87550-065	2 1/2"	22	1	75,96
87550-080	3"	10	1	128,73

87560



RACOR BARCELONA MANGUERA
HOSE COUPLING BARCELONA HOSE-HOSE



CÓDIGO	MEDIDA			€
CODE	SIZE			€
87560-020	20 x 20	120	10	11,28
87560-025	25 x 25	60	10	16,96
87560-030	30 x 30	40	5	19,87
87560-035	35 x 35	25	5	35,13
87560-040	40 x 40	22	1	29,60
87560-045	45 x 45	13	1	50,51
87560-050	50 x 50	22	1	50,78
87560-060	60 x 60	15	1	89,71

87561



RACOR BARCELONA M-M
M-M HOSE COUPLING BARCELONA



CÓDIGO	MEDIDA			€
CODE	SIZE			€
87561-015	1/2" x 1/2"	150	10	10,22
87561-020	3/4" x 3/4"	110	10	15,53
87561-025	1" x 1"	70	5	19,64
87561-032	1 1/4" x 1 1/4"	35	5	30,35
87561-040	1 1/2" x 1 1/2"	22	1	48,18
87561-050	2" x 2"	24	1	82,11

87562



RACOR BARCELONA MACHO MANGUERA
M HOSE COUPLING BARCELONA HOSE



CÓDIGO	MEDIDA			€
CODE	SIZE			€
87562-1520	1/2" x 20	140	10	10,80
87562-2025	3/4" x 25	80	10	16,99
87562-2530	1" x 30	50	5	18,65
87562-3235	1 1/4" x 35	30	5	34,05
87562-4045	1 1/2" x 45	18	1	49,91
87562-5060	2" x 60	20	1	86,14

TABLA RECAMBIO JUNTAS (RACOR BARCELONA)
GASKETS SPARE PARTS TABLE (HOSE BARCELONA)

RACOR BARCELONA	JUNTA	MEDIDA
HOSE BARCELONA	O-RING	SIZE
87560-020		
87561-015	DN15	97900-015
87562-1520		
87560-025		
87561-020	DN20	97900-020
87562-2025		
87560-030		
87561-025	DN25	97900-025
87562-2530		
87560-035		
87560-040	DN32	97900-032
87561-032		
87562-3235		
87560-045		
87561-040	DN40	97900-040
87562-4045		
87560-050	50mm.	97900-050mm.
87560-060		
87561-050	DN50	97900-050
87562-5060		

97001



RECAMBIO - JUNTA RACOR DEPÓSITO
SPARE PART - TANK OUTLET CONNECTION GASKET



CÓDIGO	MEDIDA			€
CODE	SIZE			€
97001-010	3/8"	1200	100	0,09
97001-015	1/2"	1000	50	0,13
97001-020	3/4"	700	50	0,21
97001-025	1"	500	20	0,29
97001-032	1 1/4"	300	10	0,45
97001-040	1 1/2"	250	10	0,59
97001-050	2"	200	10	0,88
97001-065	2 1/2"	150	10	0,96
97001-080	3"	90	10	1,85

97900



RECAMBIO - JUNTA RACOR BARCELONA
SPARE PART - WATERTIGHTNESS GASKET HOSE CONNECTION
BARCELONA



CÓDIGO	MEDIDA			€
CODE	SIZE			€
97900-015	15	1200	100	0,14
97900-020	20	1000	50	0,18
97900-025	25	700	50	0,24
97900-032	32	500	10	0,54
97900-040	40	250	10	0,62
97900-050MM	60	300	10	0,77
97900-050	50	180	10	1,03

87570



RACOR EXPRESS MANGUERA
HOSE EXPRESS CONNECTION



CÓDIGO	MEDIDA			€
CODE	SIZE			€
87570-016	16	100	10	5,91
87570-022	22	70	10	6,84

- Disponible hasta agotar existencias
While stocks lasts

82130



CONEXIÓN GAS TE
TEE GAS CONNECTION



CÓDIGO	MEDIDA			€
CODE	SIZE			€
82130-008	8mm.	400	10	3,13

82220



CONEXIÓN GAS Y
Y GAS CONNECTION



CÓDIGO	MEDIDA			€
CODE	SIZE			€
82220-008	8mm.	400	10	3,22

82270



MANGUITO CONEXIÓN GAS
GAS CONNECTION SOCKET



CÓDIGO	MEDIDA			€
CODE	SIZE			€
82270-008	8mm.	800	10	2,05



Rosca macho paralela / Rosca hembra paralela
Parallel male thread / Parallel female thread

SERIE 871

ACCESORIO DE LATÓN ROSCADO CROMADO

CHROME PLATED BRASS
THREADED FITTING

MATERIALES:

Cuerpo latón cromado
¼" - 1" UNE-EN-12165
1 ¼" - 4" UNE-EN-12164

COMPONENTS:

Body in chromed-plated brass
¼" - 1" UNE-EN-12165
1 ¼" - 4" UNE-EN-12164

ROSCADO CROMADO

CHROME PLATED THREADED



MÉTODO DE FABRICACIÓN:

Estampado en caliente

PRODUCTION METHOD:

Hot forged

CARACTERÍSTICAS:

Fabricado de acuerdo a la norma EN 1254-1

FEATURES:

Manufactured according to standard EN 1254-1

LEYENDA DE ICONOS

ICON KEY

Posibles codificaciones
aplicadas en esta sección.

Possible encodings applied
in this section.



Código de barras EAN
EAN bar code

PROPIEDADES DE PRODUCTO
PRODUCT PROPERTIES

871090



CODO 90° H-H
F-F ELBOW 90°

NEW



CÓDIGO	MEDIDA			€
CODE	SIZE			€
871090-010	3/8"	340	10	2,70
871090-015	1/2"	180	10	3,16
871090-020	3/4"	110	10	4,98
871090-025	1"	60	5	7,61

871092



CODO 90° M-H
M-F ELBOW 90°

NEW



CÓDIGO	MEDIDA			€
CODE	SIZE			€
871092-010	3/8"	280	10	3,13
871092-015	1/2"	200	10	3,42
871092-020	3/4"	100	10	5,12
871092-025	1"	60	5	8,37

- Rosca macho paralela
Parallel male thread

871500



RACOR CODO MURAL
WALL PLATED ELBOW

NEW



CÓDIGO	MEDIDA			€
CODE	SIZE			€
871500-015	1/2"	140	10	3,76

871130



TE IGUAL H
F EQUAL TEE

NEW



CÓDIGO	MEDIDA			€
CODE	SIZE			€
871130-010	3/8"	150	10	3,16
871130-015	1/2"	120	10	3,80
871130-020	3/4"	60	10	6,24
871130-025	1"	45	5	9,32

871240



MANGUITO REDUCCIÓN H-H
F-F REDUCING SOCKET

NEW



CÓDIGO	MEDIDA			€
CODE	SIZE			€
871240-01510	1/2" x 3/8"	300	10	2,09
871240-02015	3/4" x 1/2"	210	10	2,81

871241



TUERCA REDUCCIÓN M-H
M-F REDUCING BUSHINGS

NEW



CÓDIGO	MEDIDA			€
CODE	SIZE			€
871241-01510*	1/2" x 3/8"	500	10	1,18
871241-02015*	3/4" x 1/2"	300	10	1,77

- * Hexagonal / Hexagonal
- ** Octogonal / Octagonal
- Rosca macho paralela
Parallel male thread

871245



MACHÓN REDUCIDO M-M
M-M REDUCING NIPPLE

NEW



CÓDIGO	MEDIDA			€
CODE	SIZE			€
871245-01510	1/2" x 3/8"	500	10	1,74
871245-02015	3/4" x 1/2"	270	10	2,36

- Rosca macho paralela
Parallel male thread

871246



MANGUITO REDUCCIÓN M-H
M-F REDUCING NIPPLE SOCKET

NEW



CÓDIGO	MEDIDA			€
CODE	SIZE			€
871246-01015	3/8" x 1/2"	400	10	2,07
871246-01510	1/2" x 3/8"	500	10	1,83
871246-01520	1/2" x 3/4"	280	10	2,90
871246-02015	3/4" x 1/2"	280	10	2,57
871246-02520	1" x 3/4"	150	5	4,14

- Rosca macho paralela
Parallel male thread

871270



MANGUITO H-H
F-F SOCKET



CÓDIGO	MEDIDA			€
CODE	SIZE			€
871270-010	3/8"	400	10	1,86
871270-015	1/2"	230	10	2,50
871270-020	3/4"	140	10	3,70
871270-025	1"	100	10	5,55

871280



MACHÓN M-M
M-M HEXAGON NIPPLE



CÓDIGO	MEDIDA			€
CODE	SIZE			€
871280-010	3/8"	500	10	1,28
871280-015	1/2"	300	10	1,82
871280-020	3/4"	200	10	2,74
871280-025	1"	120	5	3,59

- Rosca macho paralela
Parallel male thread

871290



TAPÓN MACHO CON REBORDE
M PLUG BEADED



CÓDIGO	MEDIDA			€
CODE	SIZE			€
871290-010	3/8"	600	10	1,04
871290-015	1/2"	470	10	1,37
871290-020	3/4"	300	10	2,10
871290-025	1"	200	5	3,13

- Rosca macho paralela
Parallel male thread

871300



TAPÓN HEXAGONAL H
F HEXAGON CAP



CÓDIGO	MEDIDA			€
CODE	SIZE			€
871300-010	3/8"	600	10	1,13
871300-015	1/2"	430	10	1,43
871300-020	3/4"	300	10	2,06
871300-025	1"	200	5	3,03

871529



MANGUITO IGUAL M-H "TIPO MARSELLA"
M-F EQUAL SOCKET 'MARSELLA TYPE'



CÓDIGO	MEDIDA			€
CODE	SIZE			€
871529-010	3/8"	500	10	1,30
871529-015	1/2"	320	10	1,98
871529-020	3/4"	220	10	2,94
871529-025	1"	110	5	4,65

- Rosca macho paralela
Parallel male thread

87534



ALARGADERA M-H (HEX. INTERIOR)
M-F EXTENSION FITTING (HEXAGON INSIDE)



CÓDIGO	MEDIDA			€
CODE	SIZE			€
87534-015020	1/2" x 20 mm.	225	25	3,16
87534-015050	1/2" x 50 mm.	120	5	6,20
87534-015100	1/2" x 100 mm.	90	5	11,19

- Rosca macho paralela
Parallel male thread

871531



MANGUITO IGUAL M-H (HEXÁGONO INTERIOR)
M-F EQUAL SOCKET (HEXAGON INSIDE)



CÓDIGO	MEDIDA			€
CODE	SIZE			€
871531-015	1/2" x 1 CM	250	10	2,46

- Rosca macho paralela
Parallel male thread

NEW

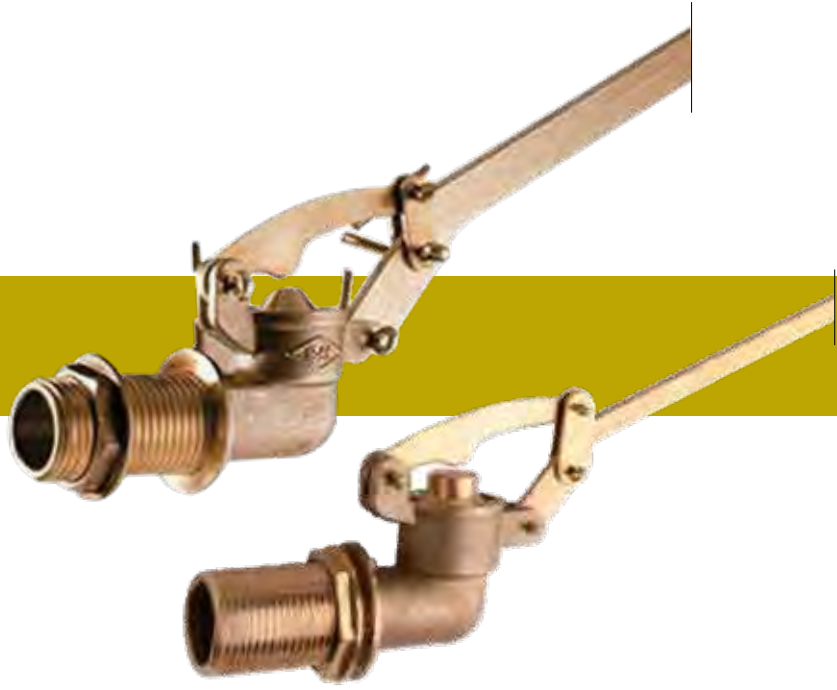

VÁLVULAS DE FLOTADOR Y BOYAS

FLOAT VALVES AND BUOYS

MATERIALES:

Cuerpo latón
¼" - 1" UNE-EN-12165
1 ¼" - 4" UNE-EN-12164

COMPONENTS:

Body in brass
¼" - 1" UNE-EN-12165
1 ¼" - 4" UNE-EN-12164

VÁL. FLOTADOR Y BOYAS

FLOAT VALVES AND BUOYS



MÉTODO DE FABRICACIÓN:

Estampado en caliente

PRODUCTION METHOD:

Hot forged

CARACTERÍSTICAS:

Fabricado de acuerdo a la norma EN 1254-1
Diseñado para uso con tubería de cobre
EN 1057:1966

FEATURES:

Manufactured according to standard EN 1254-1
Designed for use on copper pipes EN 1057:1996

LEYENDA DE ICONOS

ICON KEY

Posibles codificaciones
aplicadas en esta sección.

Possible encodings applied
in this section.



Código de barras EAN
EAN bar code

PROPIEDADES DE PRODUCTO
PRODUCT PROPERTIES

228410



VÁLVULA FLOTADOR CON VARILLA PLANA
FLOAT VALVE WITH FLAT BAR



CÓDIGO	MEDIDA			€
CODE	SIZE			€
228410-015	1/2"	-	-	Consultar
228410-020	3/4"	-	-	Consultar
228410-025	1"	-	-	Consultar
228410-032	1 1/4"	-	-	Consultar
228410-040	1 1/2"	-	-	Consultar
228410-050	2"	-	-	Consultar

228420



VÁLVULA FLOTADOR CON VARILLA ROSCADA
FLOAT VALVE WITH THREADED ROD

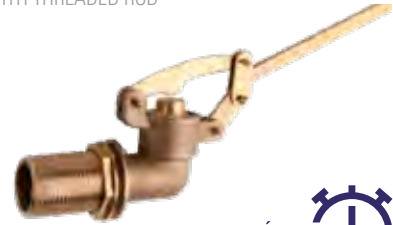

CÓDIGO	MEDIDA	ROSCA VARILLA			€
CODE	SIZE	ROD THREAD			€
228420-015	1/2"	6/100	-	-	Consultar
228420-020	3/4"	7/100	-	-	Consultar
228420-025	1"	8/100	-	-	Consultar
228420-032	1 1/4"	9/100	-	-	Consultar
228420-040	1 1/2"	9/100	-	-	Consultar
228420-050	2"	9/100	-	-	Consultar

228421



BOYA DE PLÁSTICO ESFÉRICA PARA VÁLVULA FLOTADOR CON VARILLA ROSCADA
SPHERIC PLASTIC BUOY FOR FLOAT VALVE WITH THREADED ROD



CÓDIGO	MEDIDA	ROSCA VARILLA	DIÁMETRO			€
CODE	SIZE	ROD THREAD	DIAMETER			€
228421-015	1/2"	6/100	11	-	-	Consultar
228421-020	3/4"	7/100	13	-	-	Consultar
228421-025	1"	8/100	15	-	-	Consultar
228421-03240	1 1/4" - 1 1/2"	9/100	20	-	-	Consultar
228421-050	2"	9/100	23	-	-	Consultar

228431



BOYA DE PLÁSTICO MIXTA PARA VÁLVULA FLOTADOR VARILLA PLANA Y ROSCADA
 MIXED PLASTIC BUOY FOR FLOAT VALVE WITH FLAT AND THREADED ROD



CÓDIGO	MEDIDA	ROSCA VARILLA	DIÁMETRO			€
CODE	SIZE	ROD THREAD	DIAMETER			€
228431-015	1/2"	6/100	12	-	-	Consultar
228431-020	3/4"	7/100	12	-	-	Consultar
228431-025	1"	8/100	15	-	-	Consultar
228431-03240	1 1/4" - 1 1/2"	9/100	20	-	-	Consultar
228431-050	2"	9/100	25	-	-	Consultar

Roscas de conexión según ISO 228/1
Connection threads according to standard ISO 228/1

Diseñado para
uso con tubería
de cobre
UNE-EN
1057:2007
Designed for use
with copper pipe
EN 1057:2007



Cuerpo de latón
UNE-EN-12164
Body made of brass
UNE-EN-12164

Presión máxima de trabajo:
30°C (16 Bar)
65°C (10 Bar)
110°C (6 Bar)
Max. working pressure:
30°C (16 Bar)
65°C (10 Bar)
110°C (6 Bar)

SERIE 86 ACCESORIO DE LATÓN PARA TUBERÍA DE COBRE BRASS FITTING FOR COPPER PIPE

CARACTERÍSTICAS:

Fabricado de acuerdo a la norma EN 1254-1
Diseñado para uso con tubería de cobre
UNE-EN 1057:2007

FEATURES:

Manufactured according to standard EN 1254-1
Designed for use with copper pipe EN 1057:2007

PE / Cu
PE / Cu

MT®
BRASS

Abreviaturas de materiales aplicadas en esta sección:

Abbreviations of materials applied in this section:

PE: polietileno / **PE:** polyethylene

Cu: cobre / **Cu:** copper

LEYENDA DE ICONOS

ICON KEY

Posibles codificaciones
aplicadas en esta sección.

Possible encodings applied
in this section.



Código de barras EAN
EAN bar code

PROPIEDADES DE PRODUCTO
PRODUCT PROPERTIES

86090



CODO H-Cu
F-Cu ELBOW



CÓDIGO	MEDIDA			€
CODE	SIZE			€
86090-1215	12 x 1/2"	300	25	1,62
86090-1415	14 x 1/2"	300	25	1,77
86090-1515	15 x 1/2"	250	25	1,97
86090-1815	18 x 1/2"	250	25	2,58
86090-1820	18 x 3/4"	160	10	3,96
86090-2215	22 x 1/2"	160	10	3,63
86090-2220	22 x 3/4"	130	10	4,44
86090-2820	28 x 3/4"	90	10	5,92
86090-2825	28 x 1"	70	5	7,64

86092



CODO M-Cu
M-Cu ELBOW



CÓDIGO	MEDIDA			€
CODE	SIZE			€
86092-1215	12 x 1/2"	325	25	1,69
86092-1415	14 x 1/2"	300	25	1,93
86092-1515	15 x 1/2"	300	25	2,07
86092-1815	18 x 1/2"	250	25	2,58
86092-2215	22 x 1/2"	160	10	3,17
86092-2220	22 x 3/4"	130	10	4,11

- Rosca macho paralela
Parallel male thread

86130



TE H-Cu
F-Cu TEE



CÓDIGO	MEDIDA			€
CODE	SIZE			€
86130-1215	12 x 1/2"	275	25	2,71
86130-1415	14 x 1/2"	250	25	2,64
86130-1515	15 x 1/2"	250	25	2,64
86130-1815	18 x 1/2"	150	10	3,47
86130-2215	22 x 1/2"	120	10	4,45
86130-2820	28 x 3/4"	60	5	6,88

86180



CRUZ Cu
Cu EQUAL CROSS



CÓDIGO	MEDIDA			€
CODE	SIZE			€
86180-015	15	200	10	4,27
86180-018	18	130	10	4,69
86180-022	22	80	10	6,55
86180-028	28	40	5	10,90

86472



CODO MURAL H-Cu
F-Cu WALL PLATED ELBOW



CÓDIGO	MEDIDA			€
CODE	SIZE			€
86472-1215	12 x 1/2"	240	10	3,45
86472-1415	14 x 1/2"	220	10	3,15
86472-1515	15 x 1/2"	220	10	3,15
86472-1820	18 x 3/4"	120	10	5,78
86472-2215	22 x 1/2"	120	10	5,53
86472-2220	22 x 3/4"	110	10	5,95

86243



ENTRONQUE M-Cu
M-Cu STRAIGHT CONNECTOR



CÓDIGO	MEDIDA			€
CODE	SIZE			€
86243-1215	12 x 1/2"	400	25	1,16
86243-1415	14 x 1/2"	400	25	1,11
86243-1515	15 x 1/2"	400	25	1,34
86243-1520	15 x 3/4"	350	25	2,02
86243-1815	18 x 1/2"	350	25	1,49
86243-1820	18 x 3/4"	300	25	2,10
86243-2220	22 x 3/4"	250	10	1,95
86243-2225	22 x 1"	180	10	3,18
86243-2820	28 x 3/4"	190	10	2,54
86243-2825	28 x 1"	160	10	2,94
86243-3532*	35 x 1 1/4"	100	5	5,31

86270



ENLACE H-Cu
F-Cu STRAIGHT CONNECTOR



CÓDIGO	MEDIDA			€
CODE	SIZE			€
86270-1215	12 x 1/2"	500	25	1,30
86270-1415	14 x 1/2"	475	25	1,26
86270-1515	15 x 1/2"	350	25	1,38
86270-1520	15 x 3/4"	300	25	1,85
86270-1815	18 x 1/2"	375	25	1,49
86270-1820	18 x 3/4"	275	25	2,07
86270-2215	22 x 1/2"	300	25	1,76
86270-2220	22 x 3/4"	200	10	2,51
86270-2225	22 x 1"	150	10	3,51
86270-2820	28 x 3/4"	150	10	2,56
86270-2825	28 x 1"	110	10	3,76

- Rosca macho paralela
Parallel male thread
- *Disponible hasta agotar existencias
*While stocks lasts

86301



TAPÓN Cu
Cu CAP



CÓDIGO	MEDIDA			€
CODE	SIZE			€
86301-012	12	600	25	0,69
86301-014	14	1050	25	0,86
86301-015	15	500	25	0,92
86301-018	18	500	10	1,37
86301-022	22	420	10	1,88
86301-028	28	200	5	2,80

86360



RACOR DOS PIEZAS
RECTO CON PRECINTO
H-Cu
F-Cu STRAIGHT
CONNECTION WITH
SEAL HOLE



CÓDIGO	MEDIDA			€
CODE	SIZE			€
86360-1215	12 x 1/2"	350	25	2,37
86360-1415	14 x 1/2"	325	25	2,39
86360-1515	15 x 1/2"	325	25	2,71
86360-1520	15 x 3/4"	250	25	3,83
86360-1815	18 x 1/2"	250	25	3,12
86360-1820	18 x 3/4"	190	10	4,18
86360-1825	18 x 1"	130	10	5,70
86360-2215	22 x 1/2"	210	10	4,39
86360-2220	22 x 3/4"	160	10	4,56
86360-2225	22 x 1"	120	10	6,01
86360-2825	28 x 1"	90	10	6,43

- Asiento cónico
Tapered seat

86359



RACOR DOS PIEZAS
RECTO H-Cu
F-Cu STRAIGHT TAP
CONNECTION



CÓDIGO	MEDIDA			€
CODE	SIZE			€
86359-1215	12 x 1/2"	350	25	2,05
86359-1415	14 x 1/2"	325	25	2,02
86359-1515	15 x 1/2"	325	25	2,51
86359-1520	15 x 3/4"	250	25	3,39
86359-1815	18 x 1/2"	250	25	2,73
86359-1820	18 x 3/4"	190	10	3,82
86359-1825	18 x 1"	130	10	5,23
86359-2215	22 x 1/2"	210	10	2,87
86359-2220	22 x 3/4"	160	10	4,27
86359-2225	22 x 1"	120	10	5,31
86359-2825	28 x 1"	90	10	5,74

- Asiento plano
Flat seat
- Junta plana de fibra
Fiber flat gasket

86361



RACOR DOS PIEZAS
CURVO H-Cu
F-Cu BEND TAP
CONNECTION



CÓDIGO	MEDIDA			€
CODE	SIZE			€
86361-1215	12 x 1/2"	300	25	3,39
86361-1415	14 x 1/2"	275	25	3,59
86361-1515	15 x 1/2"	225	25	3,66
86361-1520	15 x 3/4"	150	25	5,61
86361-1815	18 x 1/2"	250	25	4,76
86361-1820	18 x 3/4"	140	10	6,21
86361-1825	18 x 1"	90	10	8,86
86361-2215	22 x 1/2"	140	10	5,30
86361-2220	22 x 3/4"	130	10	7,08
86361-2225	22 x 1"	70	10	9,21

- Asiento cónico
Tapered seat

86362



ABRAZADERA TAPAPOROS
BRASS SEALING CLAMP



CÓDIGO	MEDIDA			€
CODE	SIZE			€
86362-010	10	150	10	10,06
86362-012	12	140	10	10,92
86362-015	15	90	10	15,93
86362-018	18	80	10	18,98
86362-022	22	50	10	20,70
86362-028	28	40	5	27,95
86362-035	35	25	5	34,26
86362-042	42	15	5	48,91
86362-054	54	10	5	79,21

- Para tubo cobre hidrosanitario e inoxidable
Hydrosanitary copper and stainless steel pipes

86363



ABRAZADERA TAPAPOROS CON DERIVACIÓN
BRASS SEALING CLAMP WITH FEMALE THREADED OUTLET



CÓDIGO	MEDIDA			€
CODE	SIZE			€
86363-01515	15 x 1/2"	80	10	22,32
86363-01815	18 x 1/2"	70	10	23,09
86363-02215	22 x 1/2"	50	10	25,21
86363-02820	28 x 3/4"	30	5	35,68
86363-03520	35 x 3/4"	25	5	44,77
86363-04225	42 x 1"	15	5	61,90
86363-05432	54 x 1 1/4"	10	5	101,81

- Para tubo cobre hidrosanitario e inoxidable
Hydrosanitary copper and stainless steel pipes

ACCESORIO DE LATÓN A COMPRESIÓN PARA TUBERÍA PE

BRASS COMPRESSION FITTING FOR PE PIPES



PN-25



PN-16



PN-25

CARACTERÍSTICAS GENERALES

Cuerpo, tuercas y anillos fabricados en latón UNE-EN-12165
Juntas tóricas en EPDM
Roscas conexión según ISO 7-1: Rosca macho cónica
Rosca hembra paralela
Certificación DVGW

MATERIALES:

Cuerpo en latón
UNE EN 12165
Junta tórica en EPDM
Anillo junta en latón
UNE EN 12165
Anillo compresión en latón
UNE EN 12165
Tuercas en latón
UNE-EN 12165.

LÍMITES TÉCNICOS:

Dirección de flujo:
en los dos sentidos
Límites de temperatura:
de -20 °C a + 90 °C
Presión máxima de trabajo:
S88 S99 S98: 25 Bar
S89 S97: 16 Bar

Aptas para instalaciones de
distribución de agua y fluidos.
Compatible con tubos en polie-
tileno de alta y baja densidad.

GENERAL FEATURES:

Body, nuts and press rings made of brass UNE-EN-12165
EPDM O-rings
Connection threads according to ISO 7-1: Tapered male thread
Parallel female thread
DVGW certified

COMPONENTS:

Body in brass
UNE EN 12165
O'rings in EPDM
Compression ring in
brass UNE EN 12165
Neck-ring in brass
UNE EN 12165
Nut in brass
UNE EN 12165.

TECHNICAL LIMITS:

Flow direction:
Both ways
Temperature limit from
-20 °C to + 90 °C
Maximum operating pressure:
S88 S99 S98: 25 Bar
S89 S97: 16 Bar

Suitable for use in circuits
for water distribution and
non-aggressive fluids, with
high or low density
polyethylene pipes.



SERIE
88

ACCESORIO DE LATÓN A COMPRESIÓN ROSCA HEMBRA TUBERÍA PE

BRASS COMPRESION FITTING
FEMALE THREADING PE PIPES

Presión máxima de trabajo: 25 Bar
Max. working pressure: 25 Bar



PE / PE
PE / PE

MT®
BRASS

Abreviaturas de materiales aplicadas en esta sección:

Abbreviations of materials applied in this section:

PE: polietileno / **PE:** polyethylene

LEYENDA DE ICONOS ICON KEY

Posibles codificaciones
aplicadas en esta sección.

Possible encodings applied
in this section.



CERTIFICADOS DE PRODUCTO
PRODUCT CERTIFICATES



Código de barras EAN Recambios
EAN bar code Spare parts

PROPIEDADES DE PRODUCTO
PRODUCT PROPERTIES

88010



MANGUITO ACOPLAMIENTO PE-PE
PE-PE STRAIGHT COUPLING



CÓDIGO	MEDIDA			€
CODE	SIZE			€
88010-020	20	80	10	7,76
88010-025	25	50	10	12,12
88010-032	32	30	5	16,17
88010-040	40	20	2	26,49
88010-050	50	13	1	39,05
88010-063	63	14	1	64,37

- Tope DN20-DN40; Sin tope DN50-DN63
Stopper DN20-DN40; without stopper DN50-DN63

88030



CODO 90° PE-PE
PE-PE ELBOW 90°



CÓDIGO	MEDIDA			€
CODE	SIZE			€
88030-020	20	70	10	8,59
88030-025	25	40	10	13,24
88030-032	32	25	5	20,58
88030-040	40	14	2	34,48
88030-050	50	9	1	51,19
88030-063	63	10	1	81,47

88050



RACOR TE IGUAL
PE EQUAL TEE



CÓDIGO	MEDIDA			€
CODE	SIZE			€
88050-020	20	40	10	12,59
88050-025	25	30	10	19,02
88050-032	32	15	5	29,02
88050-040	40	10	2	46,56
88050-050	50	6	1	71,47
88050-063	63	7	1	116,12

88090



RACOR RECTO MACHO PE-M
PE-M MALE COUPLING



CÓDIGO	MEDIDA			€
CODE	SIZE			€
88090-02015	20 x 1/2"	140	10	4,64
88090-02520	25 x 3/4"	90	10	6,58
88090-03225	32 x 1"	50	5	9,81
88090-04032	40 x 1 1/4"	30	2	17,02
88090-05040	50 x 1 1/2"	18	1	25,64
88090-06350	63 x 2"	22	1	39,85

- Rosca macho cónica
Tapered male thread

88110



RACOR RECTO HEMBRA PE-H
PE-F FEMALE COUPLING



CÓDIGO	MEDIDA			€
CODE	SIZE			€
88110-02015	20 x 1/2"	120	10	4,91
88110-02520	25 x 3/4"	70	10	7,32
88110-03225	32 x 1"	45	5	10,63
88110-04032	40 x 1 1/4"	30	2	17,92
88110-05040	50 x 1 1/2"	20	1	26,71
88110-06350	63 x 2"	25	1	46,74

88130



CODO 90° MACHO PE-M
PE-M MALE ELBOW 90°



CÓDIGO	MEDIDA			€
CODE	SIZE			€
88130-02015	20 x 1/2"	90	10	6,49
88130-02520	25 x 3/4"	60	10	9,49
88130-03225	32 x 1"	40	5	14,25
88130-04032	40 x 1 1/4"	22	2	24,74
88130-05040	50 x 1 1/2"	13	1	36,72
88130-06350	63 x 2"	15	1	58,77

- Rosca macho cónica
Tapered male thread

88150



CODO 90° HEMBRA PE-H
PE-F FEMALE ELBOW 90°



CÓDIGO	MEDIDA			€
CODE	SIZE			€
88150-02015	20 x 1/2"	90	10	6,26
88150-02520	25 x 3/4"	50	10	9,84
88150-03225	32 x 1"	35	5	16,10
88150-04032	40 x 1 1/4"	24	2	24,32
88150-05040	50 x 1 1/2"	13	1	37,75
88150-06350	63 x 2"	14	1	64,34

88170



RACOR TE MACHO PE-M
PE-M MALE TEE



CÓDIGO	MEDIDA			€
CODE	SIZE			€
88170-02015	20 x 1/2"	60	10	9,75
88170-02520	25 x 3/4"	30	10	14,73
88170-03225	32 x 1"	20	5	21,96
88170-04032	40 x 1 1/4"	10	2	36,26
88170-05040	50 x 1 1/2"	7	1	57,81
88170-06350	63 x 2"	9	1	96,60

- Rosca macho cónica
Tapered male thread

88190



RACOR TE HEMBRA PE-H
PE-F FEMALE TEE



CÓDIGO	MEDIDA			€
CODE	SIZE			€
88190-02015	20 x 1/2"	60	10	9,74
88190-02520	25 x 3/4"	30	10	14,95
88190-03225	32 x 1"	20	5	22,18
88190-04032	40 x 1 1/4"	10	2	38,29
88190-05040	50 x 1 1/2"	7	1	63,23
88190-06350	63 x 2"	9	1	96,61

88500



RACOR CODO MURAL
WALL PLATED ELBOW



CÓDIGO	MEDIDA			€
CODE	SIZE			€
88500-02015	20 x 1/2"	60	10	9,72
88500-02520	25 x 3/4"	40	10	13,56
88500-03225	32 x 1"	25	5	21,58

4100



VÁLVULA ESFERA PN-30 PALANCA INOX. COLOR ROJO CON
CONEXIÓN PE BALL VALVE PN-30 RED S.S. HANDLE WITH
CONNECTIONS PE



CÓDIGO	MEDIDA			€
CODE	SIZE			€
4100-020	20	24	6	16,30
4100-025	25	16	4	23,96
4100-032	32	12	3	34,73

4101



VÁLVULA ESFERA PN-30 PALANCA INOX. COLOR ROJO CON
CONEXIÓN PE-H BALL VALVE PN-30 RED S.S. HANDLE WITH
CONNECTIONS PE-H



CÓDIGO	MEDIDA			€
CODE	SIZE			€
4101-01520	1/2" x 20	32	8	12,93
4101-02025	3/4" x 25	24	6	18,82
4101-02532	1" x 32	16	4	27,68

889901



CONO DE PRESIÓN INTERNO
INTERNAL PRESSURE CONE



CÓDIGO	MEDIDA			€
CODE	SIZE			€
889901-020	20	250	10	0,67
889901-025	25	150	10	0,97
889901-032	32	100	10	1,60
889901-040	40	50	10	3,08
889901-050	50	40	10	5,23
889901-063	63	36	1	8,57

88900



RECAMBIO - ANILLO COMPRESIÓN PLÁSTICO
SPARE PART - PLASTIC COMPRESSION RING



CÓDIGO	MEDIDA			€
CODE	SIZE			€
88900-020	20	1000	25	0,14
88900-025	25	600	25	0,17
88900-032	32	320	10	0,21
88900-040	40	200	10	0,35
88900-050	50	160	10	0,41
88900-063	63	90	10	0,82

88901



RECAMBIO - ANILLO COMPRESIÓN LATÓN
SPARE PART - BRASS COMPRESSION RING



CÓDIGO	MEDIDA			€
CODE	SIZE			€
88901-020	20	900	25	0,65
88901-025	25	500	25	1,10
88901-032	32	280	10	1,45
88901-040	40	160	10	2,50
88901-050	50	120	10	3,35
88901-063	63	70	10	6,59

88902



RECAMBIO - JUNTA TÓRICA NBR 70
SPARE PART - O-RING NBR 70



CÓDIGO	MEDIDA			€
CODE	SIZE			€
88902-020	20	1000	25	0,17
88902-025	25	600	25	0,28
88902-032	32	320	10	0,35
88902-040	40	200	10	0,58
88902-050	50	160	10	0,91
88902-063	63	90	10	1,04



Presión máxima de trabajo: 25 Bar
Max. working pressure: 25 Bar

Uso en agua fría y caliente.
Use of cold and hot water.

Rosca macho cónica /
Rosca hembra paralela
Tapered male thread /
Parallel female thread

Compatible
con tuberías PE
Compatible to
PE pipes

LEYENDA DE ICONOS
ICON KEY

Posibles codificaciones
aplicadas en esta sección.

Possible encodings applied
in this section.

ACS



CERTIFICADOS DE PRODUCTO
PRODUCT CERTIFICATES



R

Código de barras EAN Recambios
EAN bar code Spare parts

PROPIEDADES DE PRODUCTO
PRODUCT PROPERTIES



SERIE 99

ACCESORIO DE LATÓN A COMPRESIÓN ROSCA MACHO TUBERÍA PE

BRASS COMPRESION FITTING MALE
THREADING PE PIPES

PE / PE
PE / PE



MATERIALES:

Cuerpo, tuercas y anillos fabricados en latón UNE-EN-12164
Juntas en EPDM
Roscas conexión según 7-1

CARACTERÍSTICAS:

Certificación ACS

COMPONENTS:

Body, nuts and press rings made of brass UNE-EN-12164
EPDM O-rings
Connection threads according to 7-1

FEATURES:

ACS certified

Abreviaturas de materiales aplicadas en esta sección:

Abbreviations of materials applied in this section:

PE: polietileno / **PE:** polyethylene

99010



MANGUITO ACOPLAMIENTO PE-PE
PE-PE STRAIGHT COUPLING



CÓDIGO	MEDIDA			€
CODE	SIZE			€
99010-020	20	80	10	8,91
99010-025	25	50	10	11,61
99010-032	32	35	5	17,80
99010-040	40	24	2	29,17
99010-050	50	16	1	40,14
99010-063	63	18	1	68,53

- Tope DN20-DN40; Sin tope DN50/DN63
Stopper DN20-DN40; without stopper DN50/DN63

99020



MANGUITO ACOPLAMIENTO PE-PE EXTRA LARGO
PE-PE EXTRA LARGE SOCKET



CÓDIGO	MEDIDA			€
CODE	SIZE			€
99020-020	20	40	10	13,64
99020-025	25	30	10	16,61
99020-032	32	28	4	22,62
99020-040	40	16	2	33,05
99020-050	50	9	1	53,98
99020-063	63	12	1	87,81

- Sin tope
Without stopper

99030



CODO 90° PE-PE
PE-PE EQUAL ELBOW 90°



CÓDIGO	MEDIDA			€
CODE	SIZE			€
99030-020	20	60	10	10,14
99030-025	25	40	10	13,91
99030-032	32	25	5	20,43
99030-040	40	18	2	33,75
99030-050	50	11	1	46,98
99030-063	63	12	1	76,83

99050



RACOR TE PE
PE EQUAL TEE



CÓDIGO	MEDIDA			€
CODE	SIZE			€
99050-020	20	40	10	14,11
99050-025	25	30	10	20,88
99050-032	32	15	5	31,77
99050-040	40	12	2	41,87
99050-050	50	6	1	68,06
99050-063	63	8	1	111,43

99090



RACOR RECTO MACHO PE-M
PE-M STRAIGHT MALE COUPLING



CÓDIGO	MEDIDA			€
CODE	SIZE			€
99090-02015	20 x 1/2"	130	10	5,58
99090-02515	25 x 1/2"	100	10	7,25
99090-02520	25 x 3/4"	90	10	7,55
99090-03225	32 x 1"	50	5	11,24
99090-04032	40 x 1 1/4"	36	2	17,13
99090-05040	50 x 1 1/2"	26	1	25,49
99090-06350	63 x 2"	30	1	41,81

- Rosca macho cónica
Tapered male thread

99110



RACOR RECTO HEMBRA PE-H
PE-F STRAIGHT FEMALE COUPLING



CÓDIGO	MEDIDA			€
CODE	SIZE			€
99110-02015	20 x 1/2"	120	10	5,53
99110-02515	25 x 1/2"	90	10	6,84
99110-02520	25 x 3/4"	80	10	7,20
99110-03225	32 x 1"	50	5	10,38
99110-04032	40 x 1 1/4"	36	2	16,64
99110-05040	50 x 1 1/2"	25	1	23,34
99110-06350	63 x 2"	28	1	42,85

99130



CODO MACHO PE-M
PE-M MALE ELBOW



CÓDIGO	MEDIDA			€
CODE	SIZE			€
99130-02015	20 x 1/2"	90	10	7,11
99130-02520	25 x 3/4"	60	10	9,22
99130-03225	32 x 1"	35	5	14,16
99130-04032	40 x 1 1/4"	22	2	23,50
99130-05040	50 x 1 1/2"	16	1	33,39
99130-06350	63 x 2"	17	1	54,19

- Rosca macho cónica
Tapered male thread

99150



CODO HEMBRA PE-H
PE-F FEMALE ELBOW



CÓDIGO	MEDIDA			€
CODE	SIZE			€
99150-02015	20 x 1/2"	100	10	6,51
99150-02515	25 x 1/2"	80	10	8,97
99150-02520	25 x 3/4"	70	10	9,42
99150-03225	32 x 1"	40	5	13,26
99150-04032	40 x 1 1/4"	24	2	21,87
99150-05040	50 x 1 1/2"	18	1	32,60
99150-06350	63 x 2"	20	1	50,80

99170



RACOR TE MACHO PE-M-PE
PE-M-PE MALE TEE



CÓDIGO	MEDIDA			€
CODE	SIZE			€
99170-02015	20 x 1/2"	50	10	10,97
99170-02520	25 x 3/4"	30	10	14,10
99170-03225	32 x 1"	20	5	21,79

- Rosca macho cónica
Tapered male thread

99190



RACOR TE HEMBRA PE-H-PE
PE-F-PE FEMALE TEE



CÓDIGO	MEDIDA			€
CODE	SIZE			€
99190-02015	20 x 1/2"	50	10	11,90
99190-02515	25 x 1/2"	40	10	14,33
99190-02520	25 x 3/4"	30	10	15,03
99190-03225	32 x 1"	20	5	21,78
99190-04032	40 x 1 1/4"	14	2	33,60
99190-05040	50 x 1 1/2"	6	1	51,20
99190-06350	63 x 2"	10	1	82,89

99120



RACOR DOS PIEZAS RECTO PE-H
PE-F STRAIGHT TAP CONNECTOR



CÓDIGO	MEDIDA			€
CODE	SIZE			€
99120-02015	20 x 1/2"	100	10	7,46
99120-02020	20 x 3/4"	90	10	7,68
99120-02520	25 x 3/4"	60	10	10,64
99120-03225	32 x 1"	45	5	16,68

99500



RACOR CODO MURAL PE-H
PE-F WALL PLATED ELBOW



CÓDIGO	MEDIDA			€
CODE	SIZE			€
99500-02015	20 x 1/2"	60	10	9,08
99500-02515	25 x 1/2"	50	10	11,69
99500-02520	25 x 3/4"	40	10	12,36
99500-03225	32 x 1"	25	5	18,03

889901



CONO DE PRESIÓN INTERNO
INTERNAL PRESSURE CONE



CÓDIGO	MEDIDA			€
CODE	SIZE			€
889901-020	20	250	10	0,67
889901-025	25	150	10	0,97
889901-032	32	100	10	1,60
889901-040	40	50	10	3,08
889901-050	50	40	10	5,23
889901-063	63	36	1	8,57

99902



RECAMBIO - JUNTA TÓRICA DE ESTANQUEIDAD NBR70
SPARE PART - WATERTIGHTNESS O'RING NBR70



CÓDIGO	MEDIDA			€
CODE	SIZE			€
99902-020	20	1	1	0,28
99902-025	25	1	1	0,28
99902-032	32	1	1	0,46
99902-040	40	1	1	0,63
99902-050	50	1	1	1,09
99902-063	63	1	1	1,28

99901



RECAMBIO - ANILLO DE COMPRESIÓN LATÓN
SPARE PART - BRASS COMPRESSION RING



CÓDIGO	MEDIDA			€
CODE	SIZE			€
99901-020	20	1200	25	0,60
99901-025	25	750	25	0,71
99901-032	32	420	10	1,10
99901-040	40	230	10	1,48
99901-050	50	150	10	2,93
99901-063	63	100	10	4,24

Garantizada para su uso en
agua fría y caliente
Guaranteed for the use of
cold and hot

Tornillos en acero inoxidable
Stainless steel bolts

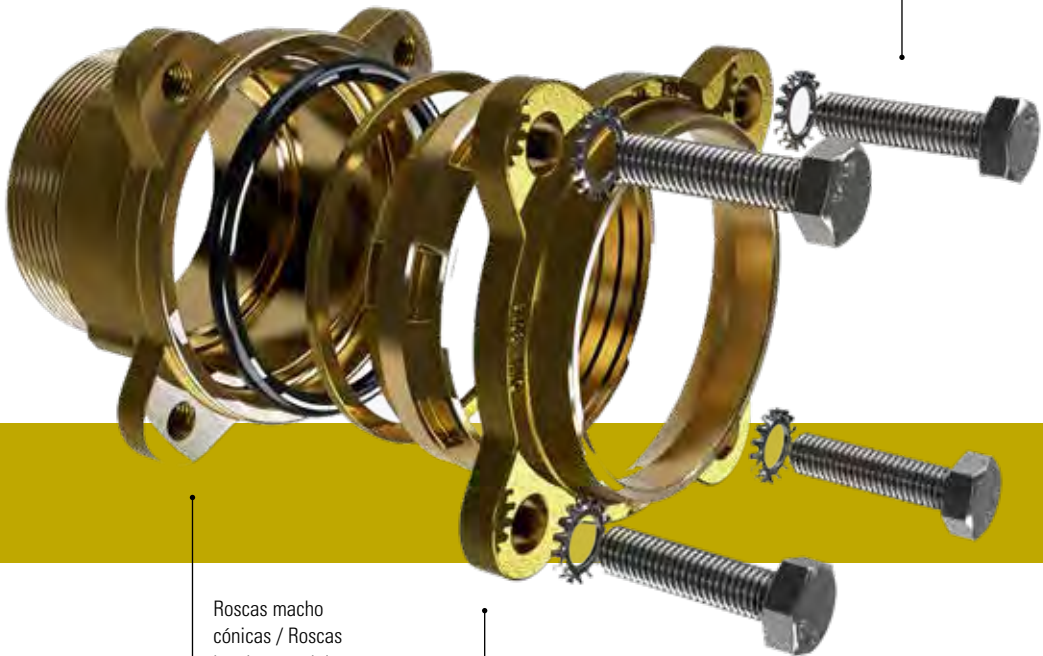

Roscas macho
cónicas / Roscas
hembra paralelas
Tapered male
threads / Parallel
female threads

Presión máxima de trabajo: 16 Bar (PN-16)
Max. working pressure: 16 Bar (PN-16)

LEYENDA DE ICONOS
ICON KEY

Posibles codificaciones
aplicadas en esta sección.

Possible encodings applied
in this section.



Código de barras EAN Recambios
EAN bar code Spare parts

PROPIEDADES DE PRODUCTO
PRODUCT PROPERTIES

SERIE 89

ACCESORIO DE LATÓN A COMPRESIÓN CON BRIDAS TUBERÍA PE BRASS COMPRESION FLANGE FITTING PE PIPES

PE / PE
PE / PE



MATERIALES:

Cuerpo, contrabrida y anillos fabricados en latón UNE-EN-12164
Juntas tóricas en EPDM
Tornillería en acero inoxidable AISI-304
Roscas conexión según ISO 7-1
Rosca macho cónica
Rosca hembra paralela

COMPONENTS:

Body, counter flange and rings made of brass UNE-EN-12164
EPDM O-rings
Stainless steel bolts AISI-304
Connection threads according to ISO 7-1
Tapered male thread
Parallel female thread

Abreviaturas de materiales aplicadas en esta sección:

Abbreviations of materials applied in this section:

PE: polietileno / **PE:** polyethylene

89022



MANGUITO ACOPLAMIENTO PE-PE
PE-PE STRAIGHT COUPLING



CÓDIGO	MEDIDA			€
CODE	SIZE			€
89022-075	75	4	1	121,88
89022-090	90	4	1	193,63
89022-110	110	2	1	292,30

- Tornillos en acero inoxidable
Stainless steel bolts
- Tope manguera
Hose stopper

89042



RACOR CODO 90° PE-PE
PE-PE EQUAL ELBOW 90°



CÓDIGO	MEDIDA			€
CODE	SIZE			€
89042-075	75	3	1	147,89
89042-090	90	1	1	245,26
89042-110	110	1	1	369,69

- Tornillos en acero inoxidable
Stainless steel bolts

89062



RACOR TE PE
PE TEE PIECE



CÓDIGO	MEDIDA			€
CODE	SIZE			€
89062-075	75	2	1	285,18
89062-090	90	1	1	348,14
89062-110	110	1	1	540,59

- Tornillos en acero inoxidable
Stainless steel bolts

89102



RACOR RECTO PE-M
PE-M COUPLING



CÓDIGO	MEDIDA			€
CODE	SIZE			€
89102-075065	75 x 2 1/2"	6	1	77,65
89102-090080	90 x 3"	5	1	117,11
89102-110100	110 x 4"	3	1	194,85

- Tornillos en acero inoxidable
Stainless steel bolts
- Rosca macho cónica
Tapered male thread

89122



RACOR RECTO PE-H
PE-F COUPLING



CÓDIGO	MEDIDA			€
CODE	SIZE			€
89122-075065	75 x 2 1/2"	6	1	74,74
89122-090080	90 x 3"	5	1	121,75
89122-110100	110 x 4"	3	1	178,80

- Tornillos en acero inoxidable
Stainless steel bolts

89142



RACOR CODO PE-M
PE-M ELBOW 90°



CÓDIGO	MEDIDA			€
CODE	SIZE			€
89142-075065	75 x 2 1/2"	4	1	108,37
89142-090080	90 x 3"	2	1	184,46

- Tornillos en acero inoxidable
Stainless steel bolts

89162



RACOR CODO PE-H
PE-F ELBOW 90°



CÓDIGO	MEDIDA			€
CODE	SIZE			€
89162-075065	75 x 2 1/2"	4	1	95,96
89162-090080	90 x 3"	2	1	152,94
89162-110100	110 x 4"	1	1	240,60

- Tornillos en acero inoxidable
Stainless steel bolts

89202



RACOR TE PE-H-PE
PE-F-PE TEE PIECE



CÓDIGO	MEDIDA			€
CODE	SIZE			€
89202-075065	75 x 2 1/2" x 75	2	1	179,20
89202-090080	90 x 3" x 90	1	1	298,77
89202-110100	110 x 4" x 110	1	1	603,44

- Tornillos en acero inoxidable
Stainless steel bolts

89900



RECAMBIO - JUEGO DE CUATRO TORNILLOS Y ARANDELAS
SPARE PART - SET OF FOUR BOLTS AND WASHERS



CÓDIGO	MEDIDA			€
CODE	SIZE			€
89900-01	75	150	1	7,79
89900-02	90-110	130	1	9,15

- Tornillos en acero inoxidable
Stainless steel bolts

89902



RECAMBIO - JUNTA TÓRICA DE ESTANQUEIDAD NBR70
SPARE PART - WATERTIGHTNESS O-RING NBR70



CÓDIGO	MEDIDA			€
CODE	SIZE			€
89902-075	75	1	1	1,73
89902-090	90	1	1	3,65
89902-110	110	1	1	4,25

SERIE 97

RIEGO: ACCESORIO DE LATÓN PARA TUBERÍA PE A PRESIÓN

IRRIGATION: BRASS FITTING
FOR PRESSURE PE PIPES



Rosca ISO 228
Threated ISO 228

Presión máxima de trabajo: 16 Bar (PN-16)
Max. working pressure: 16 Bar (PN-16)

PE / PE
PE / PE

MT®
BRASS

Cuerpo de latón UNE-EN-12164
Body in brass UNE-EN-12164

MATERIALES:

Cuerpo en latón UNE-EN-12164
Roscas conexión según ISO 228

COMPONENTS:

Body made of brass UNE-EN-12164
Connection threads according to ISO 228

Abreviaturas de materiales aplicadas en esta sección:

Abbreviations of materials applied in this section:

PE: polietileno / **PE:** polyethylene

LEYENDA DE ICONOS ICON KEY

Posibles codificaciones
aplicadas en esta sección.

Possible encodings applied
in this section.



Código de barras EAN
EAN bar code

PROPIEDADES DE PRODUCTO
PRODUCT PROPERTIES

97130



RACOR TE PE
PE EQUAL TEE



CÓDIGO	MEDIDA	3D Model		€
CODE	SIZE			€
97130-032	32 x 32 x 32	30	5	18,04

97131



RACOR TE PE-H-PE
PE-F-PE FEMALE TEE



CÓDIGO	MEDIDA	3D Model		€
CODE	SIZE			€
97131-032	32 x 3/4" x 32	40	5	20,20

97132



RACOR TE PE-M-PE
PE-M-PE MALE TEE



CÓDIGO	MEDIDA	3D Model		€
CODE	SIZE			€
97132-032	32 x 1" x 32	40	5	16,28

97270



MANGUITO ACOPLAMIENTO PE-PE
PE-PE STRAIGHT COUPLING



CÓDIGO	MEDIDA	3D Model		€
CODE	SIZE			€
97270-032	32	75	5	9,25

- Rosca macho paralela
Parallel male thread

97280



RACOR RECTO MACHO PE-M
PE-M MALE COUPLING



CÓDIGO	MEDIDA			€
CODE	SIZE			€
97280-03225	32 x 1"	75	5	9,03

- Rosca macho paralela
Parallel male thread

97091



CODO 90° HEMBRA PE-H
PE-F FEMALE ELBOW



CÓDIGO	MEDIDA			€
CODE	SIZE			€
97091-03220	32 x 3/4"	65	5	10,03

MATERIALES:

Cuerpo, tuercas y anillos fabricados en latón UNE-EN-12164
Juntas en NBR

COMPONENTS:

Body, nuts and press rings made of brass UNE-EN-12164
NBR O-rings



LEYENDA DE ICONOS
ICON KEY

Posibles codificaciones
aplicadas en esta sección.

Possible encodings applied
in this section.



Código de barras EAN
EAN bar code

PROPIEDADES DE PRODUCTO
PRODUCT PROPERTIES

SERIE 98

ACCESORIO DE LATÓN PARA TUBO DE HIERRO

BRASS COMPRESSION FITTING
FOR IRON PIPE

COMPRESIÓN COMPRESSION



CARACTERÍSTICAS GENERALES:

Condiciones de presión según DIN-8076-1
Resiste estanqueidad probada hasta una presión de 40 Bares
Roscas conexión según ISO 228

GENERAL FEATURES:

Pressure conditions according DIN-8076-1
Resist pressure leak-tightness tested until 40 Bar
Connection threads according to ISO 228

Abreviaturas de materiales aplicadas en esta sección:

Abbreviations of materials applied in this section:

PE: polietileno / **PE:** polyethylene

Fe: hierro / **Fe:** iron

98010



MANGUITO ACOPLAMIENTO Fe-Fe
Fe-Fe STRAIGHT COUPLING



CÓDIGO	MEDIDA			€
CODE	SIZE			€
98010-021	21	70	10	14,57
98010-027	27	50	10	17,80
98010-034	34	30	5	24,84
98010-043	43	22	2	36,98
98010-049	49	15	1	61,93
98010-061	61	18	1	111,48

98020



MANGUITO HIERRO Fe-PE
Fe-PE STRAIGHT



CÓDIGO	MEDIDA			€
CODE	SIZE			€
98020-02021	20 x 21	70	10	14,94
98020-02527	25 x 27	50	10	17,34
98020-03234	32 x 34	30	5	22,14
98020-04043	40 x 43	22	2	37,99
98020-05049	50 x 49	15	1	52,13
98020-06361	63 x 61	18	1	106,05

98090



RACOR RECTO MACHO Fe-M
Fe-M STRAIGHT COUPLING



CÓDIGO	MEDIDA			€
CODE	SIZE			€
98090-02115	21 X 1/2"	120	10	9,08
98090-02720	27 x 3/4"	80	10	10,78
98090-03425	34 x 1"	55	5	15,91
98090-04332	43 x 1 1/4"	36	2	21,56
98090-04940	49 x 1 1/2"	24	1	36,10
98090-06150	61 x 2"	30	1	61,16

- Rosca macho paralela
Parallel male thread

98110



RACOR RECTO HEMBRA Fe-H
Fe-F FEMALE COUPLING



CÓDIGO	MEDIDA			€
CODE	SIZE			€
98110-02115	21 x 1/2"	100	10	8,87
98110-02720	27 x 3/4"	80	10	11,81
98110-03425	34 x 1"	50	5	18,04
98110-04332	43 x 1 1/4"	36	2	21,49
98110-04940	49 x 1 1/2"	20	1	34,87
98110-06150	61 x 2"	28	1	66,11

SERIE 66



ACCESORIO Y VÁLVULAS DE LATÓN A COMPRESIÓN PARA TUBO DE COBRE E INOXIDABLE

BRASS COMPRESSION FITTING AND
VALVES FOR COPPER AND STAINLESS
STEEL PIPE



Rosca macho paralela
Rosca hembra paralela
Parallel male thread
Parallel female thread

COMPRESIÓN COMPRESSION



MATERIALES:

Cuerpo en latón niquelado UNE EN 12164
Tuerca en latón niquelado UNE EN 12165
Anillo interior en latón
Roscas conexión según ISO228

COMPONENTS:

Nickel-plated brass body UNE EN 12164
Nickel-plated brass nut UNE EN 12165
Brass-ring
Connection threads according to ISO228

LEYENDA DE ICONOS ICON KEY

Posibles codificaciones
aplicadas en esta sección.

Possible encodings applied
in this section.



CERTIFICADOS DE PRODUCTO
PRODUCT CERTIFICATES



Código de barras EAN Recambios
EAN bar code Spare parts

PROPIEDADES DE PRODUCTO
PRODUCT PROPERTIES

6601



ENLACE DOBLE
STRAIGHT COUPLING



CÓDIGO	MEDIDA			€
CODE	SIZE			€
6601-012	12 x 12	300	10	1,75
6601-015	15 x 15	240	10	1,98
6601-018	18 x 18	160	10	2,71
6601-022	22 x 22	140	10	3,54
6601-028	28 x 28	70	10	6,30
6601-035	35 x 35	45	5	15,34
6601-042	42 x 42	35	5	19,73
6601-054	54 x 54	30	5	33,52

6601R



ENLACE DOBLE REDUCCIÓN
REDUCING STRAIGHT COUPLING



CÓDIGO	MEDIDA			€
CODE	SIZE			€
6601-01815	18 x 15	180	10	2,87
6601-02215	22 x 15	150	10	3,76
6601-02218	22 x 18	130	10	3,96
6601-02822	28 x 22	100	10	8,16

6602



ENLACE HEMBRA
FEMALE STRAIGHT COUPLING



CÓDIGO	MEDIDA			€
CODE	SIZE			€
6602-01215	12 x 1/2"	300	10	1,63
6602-01510	15 x 3/8"	220	10	1,86
6602-01515	15 x 1/2"	220	10	1,64
6602-01520	15 x 3/4"	180	10	2,42
6602-01525	15 x 1"	100	10	2,57
6602-01815	18 x 1/2"	220	10	2,11
6602-01820	18 x 3/4"	160	10	2,75
6602-02215	22 x 1/2"	150	10	3,15
6602-02220	22 x 3/4"	140	10	2,85
6602-02225	22 x 1"	100	5	4,38
6602-02820	28 x 3/4"	80	5	5,46
6602-02825	28 x 1"	80	5	5,46
6602-03532	35 X 1 1/4"	40	5	7,16
6602-04240	42 X 1 1/2"	35	5	9,15

6603



ENLACE MACHO
MALE STRAIGHT COUPLING



CÓDIGO	MEDIDA			€
CODE	SIZE			€
6603-01510	15 x 3/8"	300	10	1,56
6603-01515	15 x 1/2"	300	10	1,52
6603-01520	15 x 3/4"	190	10	2,27
6603-01815	18 x 1/2"	170	10	1,94
6603-01820	18 x 3/4"	150	10	2,42
6603-02215	22 x 1/2"	150	10	2,75
6603-02220	22 x 3/4"	140	10	2,85
6603-02225	22 x 1"	110	10	3,54
6603-02820	28 x 3/4"	100	10	5,26
6603-02825	28 x 1"	80	5	5,76
6603-03532	35 X 1 1/4"	50	5	6,63
6603-04240	42 X 1 1/2"	35	5	8,88

- Rosca macho paralela
Parallel male thread

6604



CODO 90°
ELBOW 90°



CÓDIGO CODE	MEDIDA SIZE			€ €
6604-015	15 x 15	200	10	1,98
6604-018	18 x 18	130	10	2,94
6604-022	22 x 22	90	10	3,90
6604-028	28 x 28	60	10	7,67
6604-035	35 x 35	30	5	16,34
6604-042	42 x 42	20	1	28,96
6604-054	54 x 54	28	1	34,87

6605



CODO 90° HEMBRA
FEMALE ELBOW 90°



CÓDIGO CODE	MEDIDA SIZE			€ €
6605-01515	15 x 1/2"	170	10	2,15
6605-01520	15 x 3/4"	140	10	3,53
6605-01815	18 x 1/2"	140	10	3,01
6605-01820	18 x 3/4"	110	10	3,65
6605-02215	22 x 1/2"	110	10	3,76
6605-02220	22 x 3/4"	100	10	4,16
6605-02225	22 x 1"	60	10	5,81
6605-02825	28 x 1"	60	10	8,56

6606



CODO 90° MACHO
MALE ELBOW 90°



CÓDIGO CODE	MEDIDA SIZE			€ €
6606-01515	15 x 1/2"	200	10	2,27
6606-01520	15 x 3/4"	160	10	3,28
6606-01815	18 x 1/2"	160	10	2,99
6606-01820	18 x 3/4"	130	10	3,12
6606-02215	22 x 1/2"	120	10	3,28
6606-02220	22 x 3/4"	110	10	3,76
6606-02225	22 x 1"	70	10	6,04
6606-02825	28 x 1"	60	5	8,30

- Rosca macho paralela
Parallel male thread

6607



TAPÓN
CAP



CÓDIGO CODE	MEDIDA SIZE			€ €
6607-015	15	400	10	1,88
6607-018	18	350	10	2,65
6607-022	22	230	10	3,75

6608



TE IGUAL
EQUAL TEE



CÓDIGO	MEDIDA			€
CODE	SIZE			€
6608-015	15 x 15 x 15	120	10	3,17
6608-018	18 x 18 x 18	80	10	4,53
6608-022	22 x 22 x 22	60	10	5,65
6608-028	28 x 28 x 28	35	5	10,80
6608-035	35 x 35 x 35	20	5	22,16
6608-042	42 x 42 x 42	15	1	35,15
6608-054	54 x 54 x 54	18	1	60,36

6609



TE REDUCIDA
REDUCING TEE



CÓDIGO	MEDIDA			€
CODE	SIZE			€
6609-0152215	15 x 22 x 15	80	10	4,15
6609-0181518	18 x 15 x 18	80	10	4,61
6609-0181815	18 x 18 x 15	80	10	4,68
6609-0221515	22 x 15 x 15	90	10	5,28
6609-0221522	22 x 15 x 22	70	10	5,28
6609-0221822	22 x 18 x 22	70	10	5,81
6609-0222215	22 x 22 x 15	70	10	5,66
6609-0282222	28 x 22 x 22	50	10	9,83
6609-0282815	28 x 28 x 15	40	10	8,81
6609-0282822	28 x 28 x 22	30	10	9,06

6610



TE HEMBRA
FEMALE TEE



CÓDIGO	MEDIDA			€
CODE	SIZE			€
6610-0151515	15 x 1/2" x 15	120	10	3,23
6610-0181518	18 x 1/2" x 18	100	10	4,53
6610-0182018	18 x 3/4" x 18	80	10	5,80
6610-0221522	22 x 1/2" x 22	80	10	5,50
6610-0222022	22 x 3/4" x 22	60	10	6,01
6610-0282028	28 x 3/4" x 28	40	5	9,82
6610-0282528	28 x 1" x 28	35	5	12,09

6611



CODO PLACA
WALL PLATED ELBOW



CÓDIGO	MEDIDA			€
CODE	SIZE			€
6611-01515	15 x 1/2"	120	10	3,14
6611-01815	18 x 1/2"	100	10	4,28
6611-01820	18 x 3/4"	70	10	5,53
6611-02215	22 x 1/2"	60	10	5,53
6611-02220	22 x 3/4"	50	10	6,03

6612



CURVA PUENTE
CROSSOVER



CÓDIGO	MEDIDA			€
CODE	SIZE			€
6612-015	15 x 15	100	10	7,55
6612-018	18 x 18	60	10	10,07
6612-022	22 x 22	40	5	12,58

6650



VÁLVULA ESFERA MANDO PALOMILLA ENLACE COMPRESIÓN
LATÓN BALL VALVE BUTTERFLY HANDLE COMPRESSION BRASS
ENDS



CÓDIGO	MEDIDA			€
CODE	SIZE			€
6650-015	15	60	10	8,30
6650-018	18	60	10	9,82
6650-022	22	36	6	13,86

66901



RECAMBIO - ANILLO DE COMPRESIÓN
SPARE PART - COMPRESSION BRASS RING



CÓDIGO	MEDIDA			€
CODE	SIZE			€
66901-015	15	2500	250	0,63
66901-018	18	2000	100	0,88
66901-022	22	1500	100	1,12
66901-028	28	800	50	1,88

CARACTERÍSTICAS GENERALES

Cuerpo en latón CW617N, fabricado según normativa UNE EN 12165.

Diseñado conforme a la normativa UNE-EN ISO 21003.

Certificado conforme normativa BRL 5606.

Compatible con tubería Multicapa y tubería PEX de diámetros: Ø16x2, Ø20x2, Ø25x2.5, Ø26x3 y Ø32x3.

Estanqueidad asegurada con 2 o-rings de EPDM

Marcaje duradero (medida y fabricante) incluido en tuercas, anillos de compresión y cuerpos.

Perfil dentado con bisel de ángulo óptimo para facilitar la inserción del tubo.

GENERAL FEATURES

Body in brass CW617N, manufactured according to UNE EN 12164 and UNE EN 12165.

Designed according to standard UNE-EN ISO 21003.

Certified according to BRL 5606.

Compatible for Multilayer and PEX pipes of diameters : Ø16x2, Ø20x2, Ø25x2.5, Ø26x3 y Ø32x3.

Guaranteed sealing with 2 EPDM o-rings.

Permanent marking (size and Brand) included in nuts, compression rings and bodies.

Mechanized profile with optimum angle bevel in order to facilitate insertion of the pipe.

RANGO DE TEMPERATURA Y PRESIÓN
TEMPERATURE AND PRESSURE RANGE



95°C - 10 BAR
70°C - 12 BAR

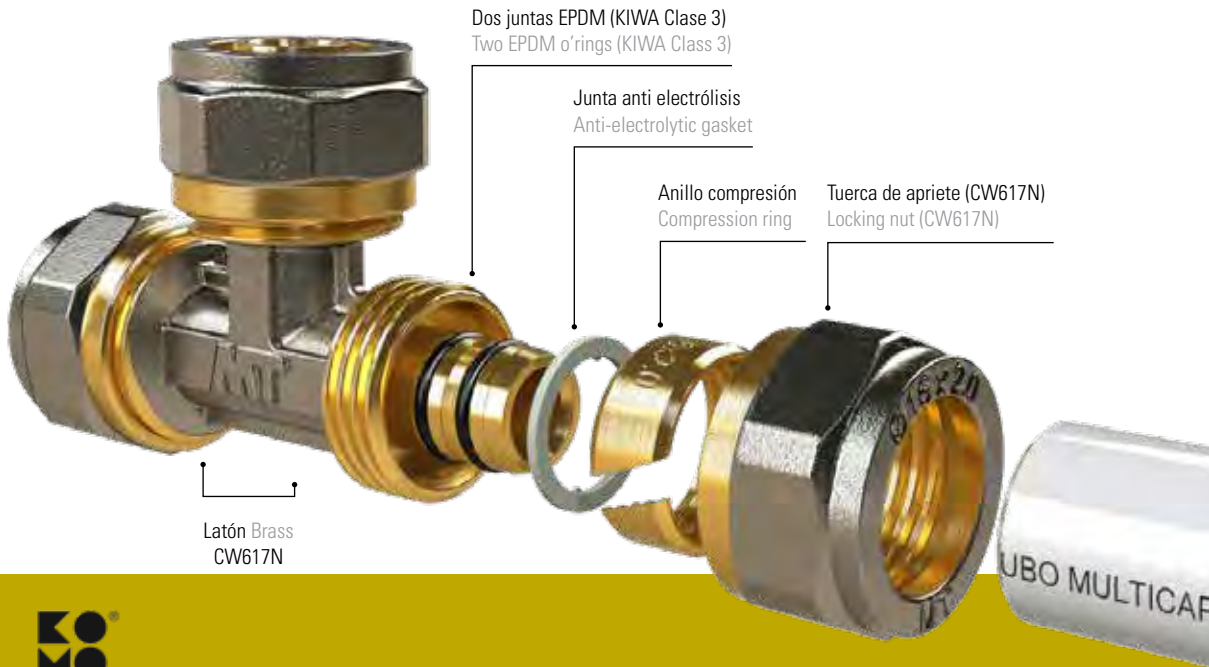

LEYENDA DE ICONOS
ICON KEY

Posibles codificaciones aplicadas en esta sección.

Possible encodings applied in this section.



Código de barras EAN
EAN bar code

PROPIEDADES DE PRODUCTO
PRODUCT PROPERTIES

ACCESORIO DE COMPRESIÓN PARA TUBERÍA MULTICAPA Y PEX

COMPRESSION FITTING FOR
MULTILAYER AND PEX PIPE

SERIE
64
1



MONTAJE

1. Cortar el tubo de forma perpendicular al eje usando el cortatubos.
2. Calibrar el tubo.
3. Introducir el tubo en el accesorio multicapa.
4. Apretar las tuercas firmemente sin torcer el tubo.

PUNTOS A FAVOR

Ideal para reparaciones.
Desmontable. Más resistencia a la temperatura gracias a sus juntas de EPDM (KIWA Clase 3).
Fácil utilización e instalación.

MOUNTING

1. Make a perpendicular cut in the pipe using the pipe cutter.
2. Calibrate the pipe.
3. Introduce multilayer pipe in the brass fitting.
4. Tighten the nuts strongly without twisting the pipe.

POSITIVE POINTS

Perfect for repairs.
Removable. High temperature resistance thanks to its EPDM joints (KIWA Class 3).
Easy to use and install.

ACC. COMPRESIÓN MULTICAPA

COMPRESSION FITTING MULTILAYER PIPES

MT®
BRASS



641090



CODO 90°
EQUAL ELBOW 90°



CÓDIGO	MEDIDA	ESPEJOR			€
CODE	SIZE	THICKNESS			€
641090-016	16	2.0	120	10	3,72
641090-018	18	2.0	100	10	5,50
641090-020	20	2.0	90	10	5,73
641090-025	25	2.5	60	5	9,17
641090-026	26	3.0	60	5	9,17
641090-032	32	3.0	40	5	17,00

641091



CODO HEMBRA 90°
FEMALE ELBOW 90°



CÓDIGO	MEDIDA	ESPEJOR			€
CODE	SIZE	THICKNESS			€
641091-01615	16 x 1/2"	2.0	150	10	3,09
641091-01620	16 x 3/4"	2.0	130	10	4,20
641091-02015	20 x 1/2"	2.0	110	10	4,62
641091-02020	20 x 3/4"	2.0	90	10	5,26
641091-02520	25 x 3/4"	2.5	60	5	7,32
641091-02525	25 x 1"	2.5	50	5	8,42
641091-02620	26 x 3/4"	3.0	60	5	7,32
641091-02625	26 x 1"	3.0	50	5	8,42
641091-03225	32 x 1"	3.0	40	5	12,86

641092



CODO MACHO 90°
MALE ELBOW 90°



CÓDIGO	MEDIDA	ESPEJOR			€
CODE	SIZE	THICKNESS			€
641092-01615	16 x 1/2"	2.0	180	10	3,07
641092-01620	16 x 3/4"	2.0	140	10	3,77
641092-01815	18 x 1/2"	2.0	130	10	3,74
641092-02015	20 x 1/2"	2.0	120	10	4,20
641092-02020	20 x 3/4"	2.0	100	10	4,80
641092-02520	25 x 3/4"	2.5	70	5	6,73
641092-02525	25 x 1"	2.5	60	5	7,94
641092-02620	26 x 3/4"	3.0	70	5	6,73
641092-02625	26 x 1"	3.0	60	5	7,94
641092-03225	32 x 1"	3.0	40	5	12,05

641270



MANGUITO ACOPLAMIENTO
STRAIGHT COUPLING



CÓDIGO	MEDIDA	ESPEJOR			€
CODE	SIZE	THICKNESS			€
641270-016	16	2.0	160	10	3,62
641270-018	18	2.0	130	10	5,50
641270-020	20	2.0	90	10	5,66
641270-025	25	2.5	70	5	10,02
641270-026	26	3.0	70	5	10,02
641270-032	32	3.0	45	5	14,37

641131



RACOR TE HEMBRA
FEMALE TEE



CÓDIGO	MEDIDA	ESPESOR			€
CODE	SIZE	THICKNESS			€
641131-01615	16 x 1/2"	2.0	100	10	4,98
641131-02015	20 x 1/2"	2.0	70	10	7,20
641131-02020	20 x 3/4"	2.0	60	10	9,06
641131-02520	25 x 3/4"	2.5	50	5	11,05
641131-02525	25 x 1"	2.5	40	5	13,04
641131-02620	26 x 3/4"	3.0	50	5	11,05
641131-02625	26 x 1"	3.0	40	5	13,04
641131-03225	32 x 1"	3.0	30	3	18,70

641132



RACOR TE MACHO
MALE TEE



CÓDIGO	MEDIDA	ESPESOR			€
CODE	SIZE	THICKNESS			€
641132-01615	16 x 1/2"	2.0	110	10	4,69
641132-02015	20 x 1/2"	2.0	80	10	6,89
641132-02020	20 x 3/4"	2.0	70	10	7,73
641132-02520	25 x 3/4"	2.5	50	5	10,42
641132-02620	26 x 3/4"	3.0	50	5	10,42
641132-03225	32 x 1"	3.0	30	3	16,19

641133



TE REDUCIDA
REDUCING TEE



CÓDIGO	MEDIDA	ESPESOR			€
CODE	SIZE	THICKNESS			€
641133-01620	16 x 20 x 16	2.0 x 2.0 x 2.0	70	10	7,31
641134-01620	20 x 16 x 16	2.0 x 2.0 x 2.0	70	10	7,31
641133-02016	20 x 16 x 20	2.0 x 2.0 x 2.0	60	10	7,97
641135-02016	20 x 20 x 16	2.0 x 2.0 x 2.0	60	10	8,13
641133-02516	25 x 16 x 25	2.5 x 2.0 x 2.5	45	5	12,04
641134-02520	25 x 20 x 20	2.5 x 2.0 x 2.0	45	5	11,59
641133-02520	25 x 20 x 25	2.5 x 2.0 x 2.5	45	5	12,69
641135-02520	25 x 25 x 20	2.5 x 2.5 x 2.0	45	5	11,59
641133-02616	26 x 16 x 26	3.0 x 2.0 x 3.0	45	5	12,04
641133-02620	26 x 20 x 26	3.0 x 2.0 x 3.0	45	5	12,69
641133-03216	32 x 16 x 32	3.0 x 2.0 x 3.0	30	3	15,95
641133-03220	32 x 20 x 32	3.0 x 2.0 x 3.0	30	3	16,92
641133-03225	32 x 25 x 32	3.0 x 2.5 x 3.0	30	3	19,27
641133-03226	32 x 26 x 32	3.0 x 3.0 x 3.0	30	3	19,27

641130



RACOR TE
EQUAL TEE



CÓDIGO	MEDIDA	ESPESOR			€
CODE	SIZE	THICKNESS			€
641130-016	16	2.0	100	10	5,29
641130-018	18	2.0	70	10	8,06
641130-020	20	2.0	60	5	8,37
641130-025	25	2.5	40	5	16,47
641130-026	26	3.0	40	5	16,47
641130-032	32	3.0	24	3	19,16

641271



RACOR RECTO HEMBRA
STRAIGHT FEMALE COUPLING



CÓDIGO	MEDIDA	ESPESOR			€
CODE	SIZE	THICKNESS			€
641271-01615	16 x 1/2"	2.0	200	10	2,57
641271-01620	16 x 3/4"	2.0	160	10	3,29
641271-02015	20 x 1/2"	2.0	140	10	3,37
641271-02020	20 x 3/4"	2.0	110	10	3,89
641271-02520	25 x 3/4"	2.5	80	5	5,82
641271-02525	25 x 1"	2.5	75	5	6,54
641271-02620	26 x 3/4"	3.0	80	5	5,82
641271-02625	26 x 1"	3.0	75	5	6,54
641271-03225	32 x 1"	3.0	55	5	9,71

641272



RACOR RECTO MACHO
STRAIGHT MALE COUPLING



CÓDIGO	MEDIDA	ESPESOR			€
CODE	SIZE	THICKNESS			€
641272-01615	16 x 1/2"	2.0	220	10	2,32
641272-01620	16 x 3/4"	2.0	180	10	2,95
641272-01815	18 x 1/2"	2.0	150	10	3,13
641272-02015	20 x 1/2"	2.0	150	10	3,53
641272-02020	20 x 3/4"	2.0	120	10	3,72
641272-02520	25 x 3/4"	2.5	80	5	5,79
641272-02525	25 x 1"	2.5	80	5	6,23
641272-02620	26 x 3/4"	3.0	80	5	5,79
641272-02625	26 x 1"	3.0	80	5	6,23
641272-03225	32 x 1"	3.0	60	3	9,70

641273



MANGUITO ACOPLAMIENTO REDUCIDO
REDUCING STRAIGHT COUPLING



CÓDIGO	MEDIDA	ESPESOR			€
CODE	SIZE	THICKNESS			€
641273-02016	20 x 16	2.0 x 2.0	110	10	4,89
641273-02520	25 x 20	2.5 x 2.0	80	5	7,95
641273-02620	26 x 20	3.0 x 2.0	80	5	7,95
641273-03225	32 x 25	3.0 x 2.5	50	5	12,62
641273-03226	32 x 26	3.0 x 3.0	50	5	12,62

641500



RACOR CODO MURAL
WALL PLATED ELBOW



CÓDIGO	MEDIDA	ESPESOR			€
CODE	SIZE	THICKNESS			€
641500-01615	16 x 1/2"	2.0	100	10	3,87
641500-02015	20 x 1/2"	2.0	80	10	5,40
641500-02020	20 x 3/4"	2.0	60	10	5,88

64015

TUBO CORRUGADO EN ROLLO
CORRUGATED PIPE ROLLS

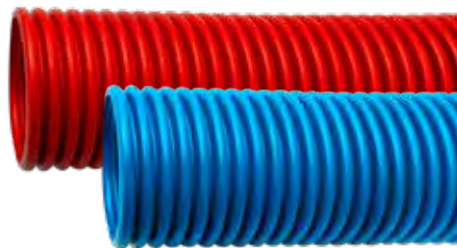

CÓDIGO	MEDIDA INTERIOR	MEDIDA TUBO	METROS	€
CODE	INNER SIZE	PIPE SIZE	METERS	€
640151-016*	16	26	50	35,39
640152-016**	16	26	50	35,39
640151-020*	20	32	50	45,42
640152-020**	20	32	50	45,42
640151-025*	25	40	50	60,30
640152-025**	25	40	50	60,30

- Precio por rollo. *Color rojo. **Color azul
Price per roll. *Red colour. **Blue colour

64016

TUBO MULTICAPA PERT-AL-PERT AISLADO
ISOLATED MULTILAYER PERT-AL-PERT PIPE



CÓDIGO	MEDIDA	ESPESOR	METROS	€
CODE	SIZE	THICKNESS	METERS	€
640161-016*	16 X 2.0	6mm	50	114,63
640162-016**	16 X 2.0	6mm	50	114,63
640161-020*	20 X 2.0	6mm	50	159,65
640162-020**	20 X 2.0	6mm	50	159,65
640161-025*	25 X 2.5	10mm	50	228,99
640162-025**	25 X 2.5	10mm	50	228,99
640161-026*	26 X 3.0	10mm	50	255,02
640162-026**	26 X 3.0	10mm	50	255,02
640161-032*	32 X 3.0	10mm	50	420,92
640162-032**	32 X 3.0	10mm	50	420,92

- Precio por rollo. *Color rojo. **Color azul
Price per roll. *Red colour. **Blue colour

640R

TUBO MULTICAPA PERT-AL-PERT EN ROLLO
MULTILAYER PIPE ROLLS PERT-AL-PERT



CÓDIGO	MEDIDA	METROS	€
CODE	SIZE	METERS	€
640-015016	16 x 2.0	15	21,74
640-025016	16 x 2.0	25	35,12
640-100016	16 x 2.0	100	122,57
640-100018	18 X 2.0	100	148,92
640-015020	20 x 2.0	15	30,71
640-025020	20 x 2.0	25	49,94
640-100020	20 x 2.0	100	179,90
640-015025	25 x 2.5	15	49,94
640-025025	25 x 2.5	25	81,66
640-050025	25 x 2.5	50	147,76
640-025026	26 x 3.0	25	90,11
640-050026	26 x 3.0	50	170,12
640-025032	32 x 3.0	25	126,45
640-050032	32 x 3.0	50	233,77

- Precio por rollo
Price per roll

640B

TUBO MULTICAPA PERT-AL-PERT EN BARRA
MULTILAYER PIPE PERT-AL-PERT BAR

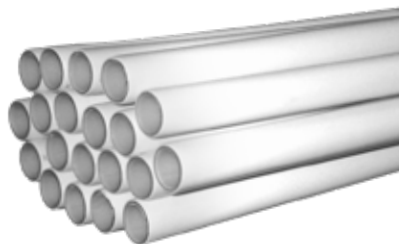

CÓDIGO	MEDIDA	METROS	BARRAS / PAQUETE	€
CODE	SIZE	METERS	BARS / BOXES	€
640-100416	16 x 2.0	4	25	133,78
640-064420	20 x 2.0	4	16	124,75
640-040425	25 x 2.5	4	10	129,37
640-028432	32 x 3.0	4	7	141,16

- Precio por paquete
Price per boxes

645

TUBO PE-Xa / PE-Xa EVOH EN ROLLO
PE-Xa PIPE / PE-Xa EVOH ROLLS



CÓDIGO	MEDIDA	METROS	€
CODE	SIZE	METERS	€
645-100016	16 x 2.0	100	99,76
645-100116*	16 x 2.0	100	130,04
645-100020	20 x 2.0	100	116,89
645-100120*	20 x 2.0	100	154,08
645-050025	25 x 2.5	50	107,86
645-050032	32 x 3.0	50	165,90

- Precio por rollo. * Tubo PE-Xa Evoh color rojo
Price per roll. * PE-Xa pipe Evoh red colour

ACCESORIO DE PRENSAR PARA TUBERÍA MULTICAPA

PRESS FITTING FOR MULTILAYER

SERIE 642

EL NUEVO ACCESORIO MT DE PRENSAR PARA TUBERÍA MULTICAPA HA SIDO DISEÑADO ESPECÍFICAMENTE PARA PODER SER USADO CON DIFERENTES TIPOS DE PERFILES DE PRENSADO : TH, H, U Y RFz.

THE NEW MT PRESS FITTING FOR MULTILAYER PIPES HAS BEEN DESIGNED SPECIFICALLY TO BE USED WITH DIFFERENT TYPE OF CRIMPING PROFILES: TH, H, U AND RFz.



TUBO		PERFILES DE PRENSADO			
PIPE		CRIMPING PROFILES			
Ø EXT	ESPEJOR	TH	H	U	RFz
Ø EXT	THICKNESS	TH	H	U	RFz
16	2.0	✓	✓	✓	✓
20	2.0	✓	✓	✓	✓
25	2.5	✓	✓	✓	✓
26	3.0	✓	✓	X	X
32	3.0	✓	✓	✓	✓

PERFIL TIPO "TH"
PROFILE TYPE 'TH'



PERFIL TIPO "H"
PROFILE TYPE 'H'



PERFIL TIPO "U"
PROFILE TYPE 'U'



PERFIL TIPO "RFz"
PROFILE TYPE 'RFz'



ACC. PRENSAR MULTICAPA

PRESS FITTING MULTILAYER PIPES



642090



CODO 90°
EQUAL ELBOW 90°



CÓDIGO	MEDIDA	ESPEJOR			€
CODE	SIZE	THICKNESS			€
642090-016	16	2.0	100	10	3,20
642090-020	20	2.0	80	10	4,47
642090-025	25	2.5	50	5	7,60
642090-026	26	3.0	50	5	7,60
642090-032	32	3.0	30	3	10,79

642091



CODO HEMBRA 90°
FEMALE ELBOW 90°



CÓDIGO	MEDIDA	ESPEJOR			€
CODE	SIZE	THICKNESS			€
642091-01615	16 X 1/2"	2.0	100	10	3,24
642091-02015	20 X 1/2"	2.0	80	10	3,97
642091-02020	20 X 3/4"	2.0	80	10	4,96
642091-02520	25 X 3/4"	2.5	50	5	6,59
642091-02525	25 X 1"	2.5	40	5	8,00
642091-02620	26 X 3/4"	3.0	50	5	6,59
642091-02625	26 X 1"	3.0	40	5	8,00
642091-03225	32 X 1"	3.0	30	3	10,47

642092



CODO MACHO 90°
MALE ELBOW 90°



CÓDIGO	MEDIDA	ESPEJOR			€
CODE	SIZE	THICKNESS			€
642092-01615	16 X 1/2"	2.0	100	10	2,94
642092-02015	20 X 1/2"	2.0	100	10	3,65
642092-02020	20 X 3/4"	2.0	80	10	4,49
642092-02520	25 X 3/4"	2.5	60	5	6,17
642092-02525	25 X 1"	2.5	50	5	7,42
642092-02620	26 X 3/4"	3.0	60	5	6,17
642092-02625	26 X 1"	3.0	50	5	7,42
642092-03225	32 X 1"	3.0	30	3	9,62

642130



RACOR TE
EQUAL TEE





CÓDIGO	MEDIDA	ESPEJOR			€
CODE	SIZE	THICKNESS			€
642130-016	16	2.0	70	5	4,60
642130-020	20	2.0	50	5	6,28
642130-025	25	2.5	36	3	10,76
642130-026	26	3.0	36	3	10,76
642130-032	32	3.0	24	2	15,04

642131



RACOR TE HEMBRA
FEMALE TEE





CÓDIGO	MEDIDA	ESPESOR			€
CODE	SIZE	THICKNESS			€
642131-01615	16 X 1/2"	2.0	70	5	4,75
642131-02015	20 X 1/2"	2.0	60	5	5,74
642131-02020	20 X 3/4"	2.0	50	5	6,74
642131-02520	25 X 3/4"	2.5	36	3	9,85
642131-02525	25 X 1"	2.5	30	3	11,39
642131-02620	26 X 3/4"	3.0	36	3	9,85
642131-02625	26 X 1"	3.0	30	3	11,39
642131-03225	32 X 1"	3.0	24	2	14,17

642132



RACOR TE MACHO
MALE TEE





CÓDIGO	MEDIDA	ESPESOR			€
CODE	SIZE	THICKNESS			€
642132-01615	16 X 1/2"	2.0	80	10	4,38
642132-02015	20 X 1/2"	2.0	60	10	5,42
642132-02020	20 X 3/4"	2.0	50	10	6,37
642132-02520	25 X 3/4"	2.5	45	5	9,40
642132-02525	25 X 1"	2.5	40	5	10,97
642132-02620	26 X 3/4"	3.0	45	5	9,40
642132-02625	26 X 1"	3.0	40	5	10,97
642132-03225	32 X 1"	3.0	24	12	14,40

642133



TE REDUCIDA
REDUCING TEE



CÓDIGO	MEDIDA	ESPESOR			€
CODE	SIZE	THICKNESS			€
642133-01620	16 x 20 x 16	2.0 x 2.0 x 2.0	50	5	5,73
642134-01620	20 x 16 x 16	2.0 x 2.0 x 2.0	50	5	5,33
642133-02016	20 x 16 x 20	2.0 x 2.0 x 2.0	50	5	5,70
642135-02016	20 x 20 x 16	2.0 x 2.0 x 2.0	50	5	6,07
642133-02516	25 x 16 x 25	2.5 x 2.0 x 2.5	36	3	8,85
642134-02520	25 x 20 x 20	2.5 x 2.0 x 2.0	42	3	8,02
642133-02520	25 x 20 x 25	2.5 x 2.0 x 2.5	36	3	9,53
642135-02520	25 x 25 x 20	2.5 x 2.5 x 2.0	36	3	9,57
642133-02616	26 x 16 x 26	3.0 x 2.0 x 3.0	36	3	8,85
642133-02620	26 x 20 x 26	3.0 x 2.0 x 3.0	36	3	9,53
642134-02620	26 X 20 X 20	3.0 x 2.0 x 2.0	42	3	8,02
642135-02620	26 X 26 X 20	3.0 x 3.0 x 2.0	36	3	9,57
642133-03216	32 x 16 x 32	3.0 x 2.0 x 3.0	30	2	11,09
642133-03220	32 x 20 x 32	3.0 x 2.0 x 3.0	30	2	11,69
642133-03225	32 x 25 x 32	3.0 x 2.5 x 3.0	24	2	13,34
642133-03226	32 x 26 x 32	3.0 x 3.0 x 3.0	24	2	13,34

642270



MANGUITO ACOPLAMIENTO
STRAIGHT COUPLING



CÓDIGO	MEDIDA	ESPESOR			€
CODE	SIZE	THICKNESS			€
642270-016	16	2.0	120	10	2,44
642270-020	20	2.0	90	10	3,15
642270-025	25	2.5	70	5	5,65
642270-026	26	3.0	70	5	5,65
642270-032	32	3.0	42	3	7,22

642271



RACOR RECTO HEMBRA
STRAIGHT FEMALE COUPLING



CÓDIGO	MEDIDA	ESPESOR			€
CODE	SIZE	THICKNESS			€
642271-01615	16 X 1/2"	2.0	120	10	2,57
642271-01620	16 X 3/4"	2.0	120	10	3,32
642271-02015	20 X 1/2"	2.0	120	10	2,85
642271-02020	20 X 3/4"	2.0	100	10	3,66
642271-02520	25 X 3/4"	2.5	70	5	4,66
642271-02525	25 X 1"	2.5	60	5	6,50
642271-02620	26 X 3/4"	3.0	70	5	4,66
642271-02625	26 X 1"	3.0	60	5	6,50
642271-03225	32 X 1"	3.0	60	3	7,38

642272



RACOR RECTO MACHO
STRAIGHT MALE COUPLING



CÓDIGO	MEDIDA	ESPESOR			€
CODE	SIZE	THICKNESS			€
642272-01615	16 x 1/2"	2.0	120	10	2,28
642272-01620	16 x 3/4"	2.0	120	10	3,03
642272-02015	20 x 1/2"	2.0	120	10	2,59
642272-02020	20 x 3/4"	2.0	100	10	3,28
642272-02520	25 x 3/4"	2.5	70	5	4,58
642272-02525	25 x 1"	2.5	60	5	5,68
642272-02620	26 x 3/4"	3.0	70	5	4,58
642272-02625	26 x 1"	3.0	60	5	5,68
642272-03225	32 x 1"	3.0	60	3	6,66

642273



MANGUITO ACOPLAMIENTO REDUCIDO
REDUCING STRAIGHT COUPLING



CÓDIGO	MEDIDA	ESPESOR			€
CODE	SIZE	THICKNESS			€
642273-02016	20 x 16	2.0 x 2.0	100	10	2,99
642273-02520	25 x 20	2.5 x 2.0	70	5	4,74
642273-02620	26 x 20	3.0 x 2.0	70	5	4,74
642273-03225	32 x 25	3.0 x 2.5	45	3	7,06
642273-03226	32 x 26	3.0 x 3.0	45	3	7,06

642274



RACOR HEMBRA TUERCA MOVIL
LOOSE NUT FEMALE COUPLING



CÓDIGO	MEDIDA	ESPESOR			€
CODE	SIZE	THICKNESS			€
642274-01615	16 x 1/2"	2.0	120	10	2,88
642274-01620	16 x 3/4"	2.0	120	10	3,66
642274-02015	20 x 1/2"	2.0	120	10	3,19
642274-02020	20 x 3/4"	2.0	100	10	4,01
642274-02520	25 x 3/4"	2.5	70	5	5,03
642274-02525	25 x 1"	2.5	60	5	6,47
642274-02620	26 x 3/4"	3.0	70	5	5,03
642274-02625	26 x 1"	3.0	60	5	6,47
642274-03225	32 x 1"	3.0	60	3	7,22

642500



RACOR CODO MURAL
WALL PLATED ELBOW



CÓDIGO	MEDIDA	ESPESOR			€
CODE	SIZE	THICKNESS			€
642500-01615	16 x 1/2"	2.0	70	10	4,13
642500-02015	20 x 1/2"	2.0	50	5	5,03
642500-02020	20 x 3/4"	2.0	40	5	5,91

40642



VÁLVULA ESFERA CONEXIÓN MULTICAPA PRENSAR CON PALANCA COLOR ROJO DE ACERO INOXIDABLE
MULTILAYER PRESS BALL VALVE WITH RED STAINLESS STEEL HANDLE

NEW



CÓDIGO	MEDIDA	ESPESOR			€
CODE	SIZE	THICKNESS			€
40642-016	16	2.0	32	8	11,07
40642-020	20	2.0	32	8	12,03
40642-025	25	2.5	16	4	14,46
40642-026	26	3.0	16	4	14,62
40642-032	32	3.0	16	4	21,28

41642



VÁLVULA ESFERA CONEXIÓN MULTICAPA PRENSAR CON MANDO PALOMILLA COLOR ROJO
MULTILAYER PRESS BALL VALVE WITH RED BUTTERFLY HANDLE

NEW



CÓDIGO	MEDIDA	ESPESOR			€
CODE	SIZE	THICKNESS			€
41642-016	16	2.0	48	12	11,19
41642-020	20	2.0	48	12	12,26
41642-025	25	2.5	28	7	14,64
41642-026	26	3.0	28	7	14,73
41642-032	32	3.0	16	4	21,49

42642



VÁLVULA ESFERA EMPOTRAR CONEXIÓN MULTICAPA PRENSAR
LONG NECK MULTILAYER BALL VALVE



CÓDIGO CODE	MEDIDA SIZE	ESPESOR THICKNESS			€
42642-016	16	2.0	32	8	11,83
42642-020	20	2.0	32	8	12,50
42642-025	25	2.5	24	6	17,17
42642-026	26	3.0	24	6	17,26
42642-032	32	3.0	12	3	24,72

6400



CALIBRADORES
GAUGES



CÓDIGO CODE	MEDIDA SIZE			€
6400-162026	16-20-25/26	40	1	9,41
6400-16202632	16-20-25/26-32	1	1	115,50

6402



MUELLE CURVATUBOS EXTERIOR
EXTERNAL BENDING SPRINGS



CÓDIGO CODE	MEDIDA SIZE			€
6402-016	16 x 2.0	30	1	5,47
6402-018	18 x 2.0	30	1	6,35
6402-020	20 x 2.0	25	1	6,86
6402-025	25 x 2.5	20	1	8,26
6402-026	26 x 3.0	20	1	8,54
6402-032	32 x 3.0	15	1	9,49

6403



CORTATUBOS AUTOMÁTICO
AUTOMATIC PIPE CUTTER



CÓDIGO CODE	MEDIDA SIZE			€
6403-1242	42	50		10,21

- Medida máxima 42mm
42mm maximum size

MAP115MLS4



Klauke
A Tebtran Company



CÓDIGO	PERFIL	€
CODE	PROFILE	€
MAP115MLS4-TH	TH	Consultar

- Opción: maletín en perfiles RFz-U y H bajo consulta.
Option: tool box with profiles RFz-U and H under request.
- Se suministra con: maletín, máquina, cargador, batería y mordaza + casquillos TH 16, 20, 25 ó 26, 32.
Supplied with: toolbox, press machine, charger, battery and clamp + crimping profiles TH 16, 20, 25 or 26, 32.

INSTRUCCIONES DE MONTAJE PARA ACCESORIO MULTICAPA FITTING MULTILAYER INSTALLATION INSTRUCTIONS

1. Cortar el tubo de forma perpendicular al eje usando el cortatubos. Make a perpendicular cut in the pipe using the pipe cutter.



2. Calibrar el tubo
Calibrate de pipe using the gauge



3. Insertar el extremo del tubo multicapa en el accesorio. Verificar mediante las ventanas de visualización que el tubo de ha insertado completamente Insert the end of the multilayer pipe in the fitting. Verify by means of their viewing windows that the pipe has been inserted completely



4. Para el prensado del accesorio, se recomienda usar una máquina con fuerza de apriete igual o superior a 15kN For pressing the fitting, it's recommended using a pressing tool which a crimping force equal to 15kN or higher



5. Posicionar correctamente la mordaza en el accesorio (imagen ejemplo con perfil "TH") Place crrectly the press crimp in the fitting (exemple picture using 'TH' profile)



6. Prensar completamente el accesorio
Press de fitting completely



7. Una vez prensado, casquillo y tubería se adaptan al perfil del accesorio garantizando la estanquidad After pressing, sleeves and pipe adapt their shapes to the fitting's profile ensuring the tightness





LEYENDA DE ICONOS

ICON KEY

Posibles codificaciones aplicadas en esta sección.

Possible encodings applied in this section.



Antihielo
Nofrost system



Inoxidable
Stainless steel



Código de barras EAN
EAN bar code



Cierre de Seguridad
Locking Device

PROPIEDADES DE PRODUCTO
PRODUCT PROPERTIES

NUEVA GAMA DE PRODUCTOS MT GARDEN

NEW MT GARDEN PRODUCT RANGE

GRIFOS DE JARDÍN Y ACCESORIOS DE LATÓN PARA LA CONEXIÓN DE MANGUERAS

- Productos de alta calidad y larga duración.
- Resistentes a los impactos y a la continua exposición solar.
- Resistentes a las mordeduras de las mascotas.
- Accesorios para mangueras de 15 y 19 mm.
- Sistema de cierre con STOP para el corte de agua.

GARDEN BIBCOCKS RANGE AND BRASS FITTINGS FOR HOSES CONNECTIONS

- High quality products and for long timer
- Resistant to impacts and to continuous solar exposure.
- Resistant to pet bites.
- Hoses accessories for 15 and 19 mm.
- With STOP closure system for close water.



Presentación en blíster para una mejor exposición en los establecimientos de venta al público
Blister presentation for a better exhibition in retail establishments

MT GARDEN

MT®
GARDEN



4131G



LANZA DE RIEGO REGULABLE
QUICK CONNECTOR ADJUSTABLE NOZZLE



CÓDIGO	MEDIDA			€
CODE	SIZE			€
4131-000G	100mm.	60	1	7,08

4134G



UNIÓN MANGUERA MANGUERA
HOSE TO HOSE CONNECTOR



CÓDIGO	MEDIDA			€
CODE	SIZE			€
4134-015G	15mm.	70	1	5,80
4134-019G	19mm.	40	1	8,39

4133G



ENCHUFE RÁPIDO
QUICK CONNECTOR



CÓDIGO	MEDIDA			€
CODE	SIZE			€
4133-015G	15mm.	70	1	5,92
4133-019G	19mm.	50	1	6,33

41332G



ENCHUFE RÁPIDO CON STOP
QUICK CONNECTOR WITH STOP



CÓDIGO	MEDIDA			€
CODE	SIZE			€
41332-015G	15mm.	70	1	5,80
41332-019G	19mm.	50	1	6,46

4132G



RACOR HEMBRA ENCHUFE RÁPIDO
FEMALE QUICK CONNECTOR



CÓDIGO	MEDIDA			€
CODE	SIZE			€
4132-015G	1/2"	70	1	2,60
4132-020G	3/4"	70	1	2,70
4132-025G	1"	60	1	3,13

4135G



RACOR MACHO ENCHUFE RÁP
MALE QUICK CONNECTOR



CÓDIGO	MEDIDA			€
CODE	SIZE			€
4135-015G	1/2"	70	1	2,92
4135-020G	3/4"	70	1	2,98

41302G



DERIVACIÓN DOS SALIDAS
TWO WAY TAP OUTLET



CÓDIGO	MEDIDA			€
CODE	SIZE			€
41302-02020G	3/4" x 3/4" x 3/4"	10	1	18,46

41303G



DERIVACIÓN TRES SALIDAS
THREE WAY TAP OUTLET



CÓDIGO	MEDIDA			€
CODE	SIZE			€
41303-02020G	3/4" x 3/4" x 3/4" x 3/4"	8	1	23,56

0921G



GRIFO ESFERA JARDÍN ENCHUFE MANGUERA PN-16 INOXIDABLE STAINLESS STEEL BIB COCK GARDEN PN-16 HOSE CONNECTOR



CÓDIGO	MEDIDA			€
CODE	SIZE			€
0921-015G	1/2"	12	1	21,27

4148G



GRIFO ESFERA JARDÍN ENCHUFE RÁPIDO PN-16 PALANCA CROMADA CON DOS SALIDAS BRASS BALL BIBCOCK GARDEN TWO OUTLETS PN-16 CHROME HANDLE WITH QUICK FEMALE CONNECTOR



CÓDIGO	MEDIDA			€
CODE	SIZE			€
4148-0152020G	1/2" x 3/4" x 3/4"	12	1	13,58

4111G



GRIFO ESFERA JARDÍN PN-16 ENCHUFE MANGUERA BRASS BALL BIBCOCK GARDEN PN-16 HOSE CONNECTOR

ANTIHELO NOFROST



CÓDIGO	MEDIDA			€
CODE	SIZE			€
4111-01520G	1/2" x 3/4"	12	1	6,64
4111-02025G	3/4" x 1"	12	1	10,12

4123G



GRIFO ESFERA JARDÍN PN-16 CON PALANCA ACERO INOXIDABLE COLOR NEGRO Y ENCHUFE RÁPIDO BRASS BALL BIBCOCK GARDEN PN-16 WITH STAINLESS STEEL BLACK HANDLE AND QUICK FEMALE CONNECTOR

ANTIHELO NOFROST



CÓDIGO	MEDIDA			€
CODE	SIZE			€
4123-01520G	1/2" x 3/4"	12	1	9,23

4145G



GRIFO JARDÍN DE LATÓN PN-10 ENCHUFE MANGUERA BRASS BIBCOCK GARDEN PN-10 HOSE CONNECTOR



CÓDIGO	MEDIDA			€
CODE	SIZE			€
4145-01520G	1/2" x 3/4"	20	1	11,40

4147G



GRIFO ESFERA JARDÍN PN-16 ENCHUFE MANGUERA PALANCA CROMADA CON CIERRE DE SEGURIDAD BRASS BALL BIBCOCK PN-16 HOSE CONNECTOR CHROME HANDLE LOCKING DEVICE

**ANTIHELO
NOFROST**



CÓDIGO	MEDIDA			€
CODE	SIZE			€
4147-01520G	1/2" x 3/4"	12	1	6,79

Presión máxima de trabajo en Bar
Maximum working pressure Bar



Rango de temperatura °C
Temperature range °C



LÍMITES TÉCNICOS:

Presión nominal: PN-25 (300 psi)
Rango de temperatura de trabajo: -20 +300°C

TECHNICAL LIMITS:

Nominal pressure: PN-25 (300 psi)
Working temperature range: -20 +300°C



Producto para agua potable, según norma EN 10204:1994
Calidad GJMB-350-10

Product for drinkable water, according to norm EN 10204:1994
Quality GJMB-350-10

LEYENDA DE ICONOS
ICON KEY

Posibles codificaciones aplicadas en esta sección.

Possible encodings applied in this section.



CERTIFICADOS DE PRODUCTO
PRODUCT CERTIFICATES

ACCESORIO DE HIERRO MALEABLE GALVANIZADO

MALLEABLE GALVANIZED
IRON FITTINGS



CARACTERÍSTICAS:

Fabricado bajo norma UNE EN 10242.
Roscas de unión de acuerdo con ISO 7-1 (DIN 2999 / BS 21).
Diámetro nominal DN bajo ISO 6708.
Dimensiones según ISO 49 y DIN 2950.

UTILIZACIÓN:

Para agua fría y caliente, aceite, aire, gas y vapor.

FEATURES:

Manufactured under UNE EN 10242.
Union threads according to ISO 7-1 (DIN 2999 / BS 21).
Nominal size DN according to ISO 6708.
Dimensions according to ISO 49 and DIN 2950.

USE:

For hot and cold water, oil, air, gas and steam.



GALVANIZADO
GALVANIZED

001

ACS

CURVA 90° M-H
M-F LONG SWEEP BEND 90°



CÓDIGO	MEDIDA			€
CODE	SIZE			€
001-010	3/8"	250	10	3,48
001-015	1/2"	180	10	3,88
001-020	3/4"	100	10	5,74
001-025	1"	40	10	7,76
001-032	1 1/4"	20	5	14,71
001-040	1 1/2"	20	5	18,68
001-050	2"	10	5	37,34
001-065	2 1/2"	5	1	73,69
001-080	3"	4	1	102,86
001-100	4"	1	1	170,76

002

ACS

CURVA 90° H-H
F-F LONG SWEEP BEND 90°



CÓDIGO	MEDIDA			€
CODE	SIZE			€
002-010	3/8"	250	10	3,68
002-015	1/2"	150	10	3,58
002-020	3/4"	80	10	5,69
002-025	1"	40	10	8,22
002-032	1 1/4"	20	5	14,70
002-040	1 1/2"	15	5	18,67
002-050	2"	10	5	33,44
002-065	2 1/2"	5	1	77,25
002-080	3"	2	1	101,69
002-100	4"	1	1	175,48

003

ACS

CURVA 90° M-M
M-M LONG SWEEP BEND 90°



CÓDIGO	MEDIDA			€
CODE	SIZE			€
003-015	1/2"	300	10	5,20
003-020	3/4"	150	10	7,35
003-025	1"	60	10	10,97
003-032	1 1/4"	40	5	22,69
003-040	1 1/2"	25	5	29,84
003-050	2"	10	5	40,01

040

ACS

CURVA 45° M-H
M-F LONG SWEEP BEND 45°



CÓDIGO	MEDIDA			€
CODE	SIZE			€
040-010	3/8"	300	10	4,18
040-015	1/2"	200	10	3,65
040-020	3/4"	120	10	4,93
040-025	1"	50	10	7,25
040-032	1 1/4"	40	5	12,04
040-040	1 1/2"	30	5	18,40
040-050	2"	15	5	29,40
040-065	2 1/2"	10	1	55,31
040-080	3"	5	1	78,98
040-100	4"	2	1	143,78

041

ACS

CURVA 45° H-H
F-F LONG SWEEP BEND 45°



CÓDIGO	MEDIDA			€
CODE	SIZE			€
041-015	1/2"	200	10	5,04
041-020	3/4"	120	10	5,48
041-025	1"	50	10	7,24
041-032	1 1/4"	40	5	12,80
041-040	1 1/2"	30	5	21,37
041-050	2"	15	5	29,84
041-065	2 1/2"	9	1	63,86
041-080	3"	5	1	80,70
041-100	4"	2	1	151,13

085

ACS

CURVA PUENTE H-H
F-F CROSSOVERS

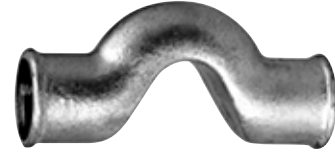

CÓDIGO	MEDIDA			€
CODE	SIZE			€
085-015	1/2"	100	10	5,36
085-020	3/4"	60	10	7,99
085-025	1"	30	10	16,49

090

ACS

CODO 90° H-H
F-F ELBOW 90°



CÓDIGO	MEDIDA			€
CODE	SIZE			€
090-008	1/4"	400	10	2,29
090-010	3/8"	250	10	1,97
090-015	1/2"	250	10	1,23
090-020	3/4"	140	10	1,73
090-025	1"	80	10	2,69
090-032	1 1/4"	40	5	4,91
090-040	1 1/2"	30	5	6,33
090-050	2"	20	5	9,68
090-065	2 1/2"	8	1	32,87
090-080	3"	6	1	50,34
090-100	4"	3	1	80,50

092

ACS

CODO 90° M-H
M-F ELBOW 90°



CÓDIGO	MEDIDA			€
CODE	SIZE			€
092-008	1/4"	700	10	2,57
092-010	3/8"	500	10	2,03
092-015	1/2"	250	10	1,58
092-020	3/4"	140	10	1,92
092-025	1"	80	10	3,20
092-032	1 1/4"	55	5	6,10
092-040	1 1/2"	30	5	8,23
092-050	2"	16	1	11,87
092-065	2 1/2"	12	1	38,11
092-080	3"	8	1	56,97
092-100	4"	4	1	76,54

090R

ACS

CODO 90° REDUCIDO H-H
F-F REDUCING ELBOW 90°



CÓDIGO CODE	MEDIDA SIZE			€ €
090-01510	1/2" x 3/8"	300	10	2,07
090-02015	3/4" x 1/2"	160	10	2,16
090-02515	1" x 1/2"	110	10	4,01
090-02520	1" x 3/4"	100	10	4,53
090-03215	1 1/4" x 1/2"	80	5	9,21
090-03220	1 1/4" x 3/4"	70	5	9,21
090-03225	1 1/4" x 1"	60	5	7,20
090-04015	1 1/2" x 1/2"	60	5	10,27
090-04020	1 1/2" x 3/4"	60	5	10,27
090-04025	1 1/2" x 1"	40	5	10,27
090-04032	1 1/2" x 1 1/4"	40	5	11,81
090-05015	2" x 1/2"	40	5	17,52
090-05020	2" x 3/4"	40	5	17,52
090-05025	2" x 1"	30	5	17,52
090-05032	2" x 1 1/4"	30	5	19,10
090-05040	2" x 1 1/2"	30	5	19,10
090-06540	2 1/2" x 1 1/2"	20	1	81,68
090-06550	2 1/2" x 2"	20	1	81,47
090-08050	3" x 2"	10	1	100,74
090-08065	3" x 2 1/2"	6	1	100,74

096

ACS

CODO UNIÓN H-H ASIENTO CÓNICO
F-F UNION ELBOW WITH TAPERED SEAT

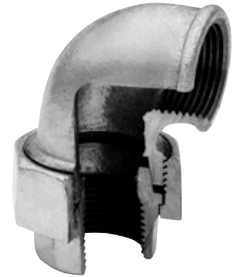

CÓDIGO CODE	MEDIDA SIZE			€ €
096-010	3/8"	120	10	7,96
096-015	1/2"	100	10	7,96
096-020	3/4"	60	10	10,06
096-025	1"	40	10	13,40
096-032	1 1/4"	30	5	25,42
096-040	1 1/2"	20	5	35,25
096-050	2"	12	1	52,56

098

ACS

CODO UNIÓN M-H ASIENTO CÓNICO
M-F ELBOW WITH TAPERED SEAT

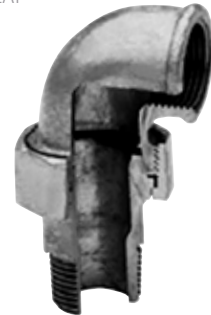

CÓDIGO CODE	MEDIDA SIZE			€ €
098-010	3/8"	80	10	9,12
098-015	1/2"	80	10	9,12
098-020	3/4"	50	10	11,87
098-025	1"	30	10	15,13
098-032	1 1/4"	20	5	25,54
098-040	1 1/2"	15	5	35,38
098-050	2"	10	5	52,88
098-065	2 1/2"	5	1	82,28

120

ACS

CODO 45° H-H
F-F ELBOW 45°



CÓDIGO	MEDIDA			€
CODE	SIZE			€
120-015	1/2"	300	10	4,68
120-020	3/4"	180	10	5,90
120-025	1"	100	10	8,56
120-032	1 1/4"	50	5	15,96
120-040	1 1/2"	40	5	20,22
120-050	2"	20	5	25,81
120-065	2 1/2"	12	1	35,66
120-080	3"	6	1	89,87
120-100	4"	3	1	89,87

180

ACS

CRUZ H
F CROSS



CÓDIGO	MEDIDA			€
CODE	SIZE			€
180-010	3/8"	110	10	11,99
180-015	1/2"	100	10	5,98
180-020	3/4"	70	10	8,93
180-025	1"	40	10	10,82
180-032	1 1/4"	20	5	15,30
180-040	1 1/2"	15	5	20,63
180-050	2"	10	5	31,95
180-065	2 1/2"	6	1	75,81
180-080	3"	5	1	87,91
180-100	4"	1	1	126,72

221

ACS

CODO TRES BOCAS H
F THREE OUTLETS ELBOW



CÓDIGO	MEDIDA			€
CODE	SIZE			€
221-015	1/2"	120	10	5,48
221-020	3/4"	70	10	6,77
221-025	1"	50	10	12,89
221-040	1 1/2"	20	5	30,63

223

ACS

CODO CUATRO BOCAS H
F ELBOW WITH TWO LATERALS





CÓDIGO	MEDIDA			€
CODE	SIZE			€
223-015	1/2"	120	10	10,18
223-020	3/4"	70	10	17,55
223-025	1"	50	10	21,68

130

ACS

TE IGUAL H
F EQUAL TEE





CÓDIGO CODE	MEDIDA SIZE			€ €
130-008	1/4"	300	10	3,32
130-010	3/8"	200	10	2,75
130-015	1/2"	150	10	1,73
130-020	3/4"	80	10	2,56
130-025	1"	50	10	3,85
130-032	1 1/4"	30	5	7,15
130-040	1 1/2"	20	5	9,36
130-050	2"	12	4	14,16
130-065	2 1/2"	8	1	48,57
130-080	3"	6	1	56,97
130-100	4"	3	1	102,38

130R

ACS

TE REDUCIDA H
F REDUCING TEE



CÓDIGO CODE	MEDIDA SIZE			€ €
130-02015	3/4" x 1/2"	120	10	3,08
130-02515	1" x 1/2"	60	10	4,71
130-02520	1" x 3/4"	60	10	4,76
130-03215	1 1/4" x 1/2"	40	5	7,56
130-03220	1 1/4" x 3/4"	40	5	8,35
130-03225	1 1/4" x 1"	30	5	8,74
130-04015	1 1/2" x 1/2"	30	5	10,37
130-04020	1 1/2" x 3/4"	30	5	10,74
130-04025	1 1/2" x 1"	30	5	10,37
130-04032	1 1/2" x 1 1/4"	25	5	16,32
130-05015	2" x 1/2"	20	5	14,21
130-05020	2" x 3/4"	20	5	19,89
130-05025	2" x 1"	20	5	15,04
130-05032	2" x 1 1/4"	15	5	19,89
130-05040	2" x 1 1/2"	15	5	22,92
130-06520	2 1/2" x 3/4"	8	1	51,64
130-06525	2 1/2" x 1"	8	1	51,64
130-06532	2 1/2" x 1 1/4"	8	1	52,69
130-06540	2 1/2" x 1 1/2"	8	1	52,69
130-06550	2 1/2" x 2"	8	1	60,20
130-08040	3" x 1 1/2"	5	1	72,80
130-08050	3" x 2"	5	1	66,18
130-08065	3" x 2 1/2"	5	1	72,80
130-10050	4" x 2"	4	1	120,18
130-10065	4" x 2 1/2"	4	1	120,18
130-10080	4" x 3"	4	1	120,18

245

ACS

MACHÓN REDUCCIÓN M-M M-M REDUCING NIPPLE



CÓDIGO CODE	MEDIDA SIZE			€ €
245-00806*	1/4" x 1/8"	800	10	2,56
245-01008	3/8" x 1/4"	500	10	2,56
245-01508	1/2" x 1/4"	300	10	2,56
245-01510	1/2" x 3/8"	200	10	2,56
245-02010	3/4" x 3/8"	250	10	4,10
245-02015	3/4" x 1/2"	250	10	2,16
245-02515	1" x 1/2"	130	10	4,72
245-02520	1" x 3/4"	130	10	2,79
245-03215	1 1/4" x 1/2"	70	5	8,52
245-03220	1 1/4" x 3/4"	70	5	6,70
245-03225	1 1/4" x 1"	70	5	4,88
245-04020	1 1/2" x 3/4"	60	5	7,08
245-04025	1 1/2" x 1"	60	5	10,21
245-04032	1 1/2" x 1 1/4"	60	5	7,68
245-05025	2" x 1"	30	5	10,86
245-05032	2" x 1 1/4"	30	5	13,57
245-05040	2" x 1 1/2"	30	5	12,26
245-06540	2 1/2" x 1 1/2"	20	1	26,50
245-06550	2 1/2" x 2"	20	1	26,50
245-08050	3" x 2"	20	1	42,14
245-08065	3" x 2 1/2"	20	1	42,14
245-10080	4" x 3"	10	1	132,87

- * Disponible hasta agotar existencias
* While stocks lasts

246

ACS

MANGUITO REDUCCIÓN H-M F-M REDUCING NIPPLE SOCKET





CÓDIGO CODE	MEDIDA SIZE			€ €
246-01008	3/8" x 1/4"	400	10	3,48
246-01508	1/2" x 1/4"	380	10	3,36
246-01510	1/2" x 3/8"	380	10	3,36
246-02010	3/4" x 3/8"	220	10	4,10
246-02015	3/4" x 1/2"	220	10	3,37
246-02515	1" x 1/2"	120	10	4,75
246-02520	1" x 3/4"	120	10	4,75
246-03215	1 1/4" x 1/2"	80	5	10,46
246-03220	1 1/4" x 3/4"	80	5	7,60
246-03225	1 1/4" x 1"	80	5	7,60
246-04020	1 1/2" x 3/4"	60	5	9,89
246-04025	1 1/2" x 1"	60	5	10,40
246-04032	1 1/2" x 1 1/4"	60	5	12,59
246-05025	2" x 1"	30	5	14,98
246-05032	2" x 1 1/4"	30	5	13,54
246-05040	2" x 1 1/2"	30	5	14,79

240

ACS

MANGUITO REDUCCIÓN H-H
F-F REDUCING SOCKET





CÓDIGO CODE	MEDIDA SIZE			€ €
240-01008	3/8" x 1/4"	600	10	2,12
240-01508	1/2" x 1/4"	400	10	2,05
240-01510	1/2" x 3/8"	400	10	2,05
240-02010	3/4" x 3/8"	250	10	2,79
240-02015	3/4" x 1/2"	240	10	2,25
240-02515	1" x 1/2"	160	10	3,14
240-02520	1" x 3/4"	160	10	2,91
240-03215	1 1/4" x 1/2"	90	5	6,58
240-03220	1 1/4" x 3/4"	90	5	5,55
240-03225	1 1/4" x 1"	90	5	5,55
240-04015	1 1/2" x 1/2"	80	5	9,50
240-04020	1 1/2" x 3/4"	70	5	8,96
240-04025	1 1/2" x 1"	60	5	6,44
240-04032	1 1/2" x 1 1/4"	50	5	6,70
240-05015	2" x 1/2"	50	5	12,75
240-05020	2" x 3/4"	50	5	13,23
240-05025	2" x 1"	50	5	13,23
240-05032	2" x 1 1/4"	40	5	11,99
240-05040	2" x 1 1/2"	40	5	10,46
240-06515	2 1/2" x 1/2"	22	1	30,28
240-06525	2 1/2" x 1"	22	1	30,24
240-06532	2 1/2" x 1 1/4"	22	1	31,37
240-06540	2 1/2" x 1 1/2"	22	1	35,38
240-06550	2 1/2" x 2"	22	1	30,78
240-08040	3" x 1 1/2"	18	1	33,36
240-08050	3" x 2"	18	1	45,87
240-08065	3" x 2 1/2"	18	1	45,87
240-10050	4" x 2"	6	1	66,58
240-10065	4" x 2 1/2"	6	1	69,52
240-10080	4" x 3"	6	1	76,97

241

ACS

TUERCA REDUCCIÓN M-H
M-F REDUCING BUSHINGS



CÓDIGO CODE	MEDIDA SIZE			€ €
241-01008	3/8" x 1/4"	1000	10	1,94
241-01508	1/2" x 1/4"	800	10	1,28
241-01510	1/2" x 3/8"	800	10	1,28
241-02008	3/4" x 1/4"	480	10	1,61
241-02010	3/4" x 3/8"	480	10	1,61
241-02015	3/4" x 1/2"	480	10	1,34
241-02508	1" x 1/4"	260	10	2,13
241-02510	1" x 3/8"	260	10	2,24
241-02515	1" x 1/2"	260	10	2,03
241-02520	1" x 3/4"	260	10	2,03
241-03215	1 1/4" x 1/2"	160	5	3,40
241-03220	1 1/4" x 3/4"	160	5	3,36
241-03225	1 1/4" x 1"	160	5	3,14
241-04010	1 1/2" x 3/8"	120	5	4,41
241-04015	1 1/2" x 1/2"	120	5	4,41
241-04020	1 1/2" x 3/4"	120	5	4,65
241-04025	1 1/2" x 1"	120	5	3,73
241-04032	1 1/2" x 1 1/4"	120	5	3,67
241-05015	2" x 1/2"	60	5	9,50
241-05020	2" x 3/4"	60	5	9,18
241-05025	2" x 1"	60	5	6,96
241-05032	2" x 1 1/4"	60	5	6,44
241-05040	2" x 1 1/2"	60	5	6,44
241-06515	2 1/2" x 1/2"	40	1	28,87
241-06520	2 1/2" x 3/4"	40	1	28,87
241-06525	2 1/2" x 1"	40	1	19,94
241-06532	2 1/2" x 1 1/4"	40	1	19,94
241-06540	2 1/2" x 1 1/2"	40	1	19,60
241-06550	2 1/2" x 2"	40	1	18,68
241-08025	3" x 1"	30	1	22,19
241-08032	3" x 1 1/4"	30	1	22,95
241-08040	3" x 1 1/2"	30	1	21,68
241-08050	3" x 2"	30	1	23,28
241-08065	3" x 2 1/2"	30	1	23,40
241-10050	4" x 2"	18	1	40,51
241-10065	4" x 2 1/2"	18	1	41,29
241-10080	4" x 3"	18	1	41,29

270

ACS

MANGUITO H-H
F-F SOCKET



CÓDIGO	MEDIDA			€
CODE	SIZE			€
270-006*	1/8"	700	10	1,94
270-008	1/4"	700	10	1,85
270-010	3/8"	400	10	1,85
270-015	1/2"	340	10	1,21
270-020	3/4"	220	10	1,51
270-025	1"	120	10	2,54
270-032	1 1/4"	60	5	3,56
270-040	1 1/2"	50	5	4,80
270-050	2"	25	5	7,71
270-065	2 1/2"	22	1	26,78
270-080	3"	18	1	34,76
270-100	4"	6	1	70,72

- * Disponible hasta agotar existencias
* While stocks lasts

280

ACS

MACHÓN M-M
M-M HEXAGON NIPPLE



CÓDIGO	MEDIDA			€
CODE	SIZE			€
280-008	1/4"	500	10	2,48
280-010	3/8"	500	10	2,25
280-015	1/2"	350	10	1,26
280-020	3/4"	250	10	1,46
280-025	1"	130	10	1,99
280-032	1 1/4"	70	5	3,81
280-040	1 1/2"	60	5	4,75
280-050	2"	30	5	7,64
280-065	2 1/2"	24	1	23,14
280-080	3"	18	1	35,98
280-100	4"	6	1	67,08

290

ACS

TAPÓN CON REBORDE M
M PLUG BEADED



CÓDIGO	MEDIDA			€
CODE	SIZE			€
290-006*	1/8"	1000	10	1,72
290-008	1/4"	1000	10	1,46
290-010	3/8"	1000	10	1,28
290-015	1/2"	800	10	0,93
290-020	3/4"	400	10	1,26
290-025	1"	250	10	1,62
290-032	1 1/4"	160	5	3,21
290-040	1 1/2"	130	5	4,31
290-050	2"	60	5	6,55
290-065	2 1/2"	50	1	15,42
290-080	3"	26	1	19,55
290-100	4"	18	1	32,26

- * Disponible hasta agotar existencias
* While stocks lasts

300

ACS

TAPÓN HEXAGONAL H
F HEXAGON CAP

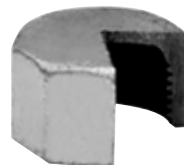

CÓDIGO	MEDIDA			€
CODE	SIZE			€
300-008	1/4"	800	10	1,55
300-010	3/8"	800	10	1,55
300-015	1/2"	600	10	1,51
300-020	3/4"	400	10	1,88
300-025	1"	250	10	2,39
300-032	1 1/4"	100	5	4,45
300-040	1 1/2"	90	5	5,20
300-050	2"	70	5	8,56
300-065	2 1/2"	25	1	19,43
300-080	3"	18	1	21,92
300-100	4"	12	1	36,67

301

ACS

TAPÓN H
F ROUND CAP

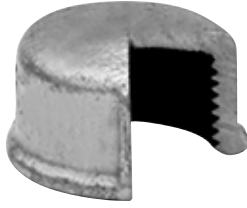

CÓDIGO CODE	MEDIDA SIZE			€ €
301-010	3/8"	800	10	1,61
301-015	1/2"	800	10	1,70
301-020	3/4"	400	10	1,85
301-025	1"	250	10	2,29
301-032	1 1/4"	100	5	3,09
301-040	1 1/2"	90	5	3,86
301-050	2"	70	5	7,70
301-065	2 1/2"	25	1	16,84
301-080	3"	18	1	18,68
301-100	4"	12	1	33,72

312

ACS

TUERCA HEXAGONAL
LOCKNUTS



CÓDIGO CODE	MEDIDA SIZE			€ €
312-010	3/8"	600	10	2,11
312-015	1/2"	600	10	1,73
312-020	3/4"	400	10	1,92
312-025	1"	250	10	2,34
312-032	1 1/4"	200	5	3,07
312-040	1 1/2"	180	5	3,84
312-050	2"	110	5	7,65

321

ACS

BRIDA REDONDA BASE ROSCADA CON TALADROS
F FLOOR FLANGE THREADED BASE WITH HOLES



CÓDIGO CODE	MEDIDA SIZE			€ €
321-015	1/2"	80	10	12,83
321-020	3/4"	60	10	14,37
321-025	1"	50	10	15,81
321-032	1 1/4"	40	5	19,69
321-040	1 1/2"	36	4	23,52
321-050	2"	24	4	27,33
321-065	2 1/2"	15	1	41,87
321-080	3"	10	1	50,14
321-100	4"	5	1	82,57

340

ACS

TUERCA UNIÓN H-H ASIENTO CÓNICO
F-F UNION WITH TAPERED SEAT



CÓDIGO CODE	MEDIDA SIZE			€ €
340-008	1/4"	150	10	8,74
340-010	3/8"	150	10	8,74
340-015	1/2"	120	10	7,39
340-020	3/4"	80	10	9,06
340-025	1"	60	10	10,94
340-032	1 1/4"	40	5	15,55
340-040	1 1/2"	30	5	20,16
340-050	2"	20	5	28,39
340-065	2 1/2"	10	1	66,46
340-080	3"	6	1	97,83
340-100	4"	2	1	188,94

- * Dimensiones agujeros según EN-1.092-1 PN-6
- * Dimensiones according EN-1.092-1 PN-6

341

ACS

TUERCA UNIÓN M-H ASIENTO CÓNICO
M-F UNION WITH TAPERED SEAT



CÓDIGO	MEDIDA			€
CODE	SIZE			€
341-008	1/4"	150	10	8,72
341-010	3/8"	150	10	8,72
341-015	1/2"	100	10	8,25
341-020	3/4"	60	10	10,60
341-025	1"	40	10	13,05
341-032	1 1/4"	30	5	17,71
341-040	1 1/2"	20	5	23,98
341-050	2"	15	5	33,69
341-065	2 1/2"	8	1	85,23
341-080	3"	6	1	137,83
341-100	4"	2	1	214,06

529

ACS

MANGUITO M/H
M-F SOCKET



CÓDIGO	MEDIDA			€
CODE	SIZE			€
529-015	1/2"	360	10	2,57
529-020	3/4"	220	10	3,85
529-025	1"	120	10	6,60
529-032	1 1/4"	80	5	5,68
529-040	1 1/2"	60	5	6,88
529-050	2"	30	5	10,52

LEYENDA DE ICONOS
ICON KEY

Posibles codificaciones aplicadas en esta sección.

Possible encodings applied in this section.



Código de barras EAN
EAN bar code

Recambios
Spare parts

CERTIFICADOS DE PRODUCTO
PRODUCT CERTIFICATES

PROPIEDADES DE PRODUCTO
PRODUCT PROPERTIES



MAC3
REDUCTORAS DE PRESIÓN
VÁLVULAS DE ESFERA
FLEXOS DE DUCHA
VÁLVULAS DE DESCARGA Y LLENADO
ADHESIVOS

MAC3
PRESSURE REDUCING VALVE
BALL VALVES
SHOWER HOSE
FLUSH AND FILL VALVES
ADHESIVES





Mac3, fabricante líder mundial de interruptores de flotador, es una sólida empresa italiana que opera en todo el mundo, ofreciendo productos electrónicos y electromecánicos de alta calidad, desarrollados específicamente para sistemas hidráulicos.

La compañía Mac3 fue fundada con la intención de ofrecer productos de calidad en el ámbito de la regulación de niveles y se ha convertido en líder mundial en la producción de interruptores de flotador. Hoy en día ofrece productos electrónicos y electromecánicos de alta calidad desarrollados específicamente para sistemas hidráulicos.

Durante sus más de 30 años de actividad, Mac3 ha desarrollado una gama de productos cada vez más completa para controlar los niveles de mando y la gestión de electrobombas en los sistemas presurizados.

Homologación ENEC

La marca ENEC es el acrónimo de “European Norms Electrical Certification”. Surge del acuerdo de 20 países europeos (ENEC acuerdo aprobado por el Cenelec Mark Committee) y certifica que un producto cumple con las normas europeas EN y está construido por las empresas con sistemas de calidad según la norma ISO 9000. A la marca ENEC se la reconoce como equivalente a las marcas individuales.

Referencias

Mac3 es sinónimo de alta tecnología y fiabilidad en todo el mundo. Su gama de productos, resultado de una cuidadosa investigación técnica de aplicación, cubren todas las necesidades de control de líquidos. Esta es la razón por la que empresas líderes en la industria del sector hidráulico nos han elegido como proveedor. Abores nonsequi omnium ius dolupta nosseque parum facepreperum facid que andi dolor autassita.

Mac3, a world leader in float switches, is a solid Italian company operating throughout the World, offering electronic and electromechanical products of excellent quality developed specifically for the hydraulic field.

The company Mac3 was founded with the aim of providing quality products in the field of regulation of levels and has become the world leader in the production of float switches. Today it offers electronic and electromechanical products with high quality and developed specifically for the hydraulics.

ENEC approval

The ENEC mark stands for “European Norms Electrical certification”. It is the fruit of agreements with 20 European bodies (ENEC agreement approved by the Cenelec Mark Committee) which certifies that the product complies with the EN European norms and has been produced by companies certified in accordance with ISO 9000 quality standards. The ENEC mark is recognized as being equivalent to individual national marks.

References

Mac3 is synonymous around the World of high technology and reliability. The product range, which is the result of extensive technical and applicative research, covers all liquid control. This is why leading companies in the plumbing industry have chosen us as a supplier.



KEY

REGULADOR DE NIVEL ELECTROMECÁNICO ELECTROMECHANICAL FLOAT SWITCHES



Tiene una elevada fiabilidad, es el más usado del mundo para la automatización de electrobombas y en tanques de almacenamiento. Su tamaño lo hace más versátil para cada aplicación. Para aguas limpias.

High reliability, is the most universally used float switch in the world for the automation of pumps and storage tanks. Its size makes it the most versatile for any application. For clean water.

CÓDIGO	MEDIDA	€
CODE	SIZE	€
KPM0206KY0C	2 M CABLE PVC 3X1 μ 16 (4)	15,72
KPM0306KY0C	3 M CABLE PVC 3X1 μ 16 (4)	16,56
KPM0506KY0C	5 M CABLE PVC 3X1 μ 16 (4)	19,61

- Contrapeso incluido
Including counterweight

MAC3

REGULADOR DE NIVEL ELECTROMECÁNICO ELECTROMECHANICAL FLOAT SWITCHES



Es el producto histórico, tiene un buen tamaño y una forma libre de rugosidad que lo hace adecuado para instalaciones con aguas residuales. Dispositivo fabricado con doble cámara estanca para máxima seguridad, es el producto más fiable del mercado.

The historical device, thanks to its large size and its shape without edges, for which it is particularly suitable for sewage water, this device is made with a double liquid proof chamber which assures the maximum reliability of the inside.

CÓDIGO	MEDIDA	€
CODE	SIZE	€
MPM0206GBOC	2 M CABLE PVC 3X1 μ 16 (4)	17,62
MPM0306GBOC	3 M CABLE PVC 3X1 μ 16 (4)	19,15
MPM0506GBOC	5 M CABLE PVC 3X1 μ 16 (4)	22,21
MPM1006GBOC	10 M CABLE PVC 3X1 μ 16 (4)	29,86

- Contrapeso incluido
Including counterweight

AGMA

REGULADOR NIVEL AGUAS RESIDUALES SMALL WELLS REGULATOR



Dispositivo muy compacto normalmente instalado en bombas de drenaje. Tal dispositivo se puede incluso usar cuando hay sedimentos en el agua. Cuando no se puedan usar flotadores tradicionales; el dispositivo se puede usar en aguas residuales, previa verificación y limpieza periódica de los mecanismos de flotación. Para aguas limpias y residuales.

Compact device usually installed on drainage pumps. This device is useful even in the presence of debris in the water. If it is not possible to use a floating tilting, it can also be used in the presence of waste water in compliance with periodical verification and cleaning of the mechanisms of buoyancy. Clean and sewage water.

CÓDIGO	MEDIDA	€
CODE	SIZE	€
AGWPC50000	50 cm. CABLE PVC 3X1 μ20(8)	25,77
AGWPM03000	3 m. CABLE PVC 3X1 μ20(8)	29,53
AGWPM05000	5 m. CABLE PVC 3X1 μ20(8)	32,53

MAC5

REGULADOR NIVEL AGUAS RESIDUALES ELECTROMECHANICAL FLOAT SWITCHES FOR SEWAGE WATER



Regulador de nivel por inclinación para aguas residuales del alcantarillado. Tiene un cuerpo pesado, voluminoso y carente de asperezas que lo hace ideal para su uso en aguas residuales de alcantarillado, industriales con residuos de aglomerados en suspensión y aguas turbulentas. Fabricado con una doble cámara estanca. Disponibles en diversos tipos de cable ideales para distintas instalaciones.

Tilting level regulator for sewage water. It's principal feature being its heavy body, which is also bulky and free of any irregularity, making it ideal for use in sewage water, in industrial waste with suspended agglomerate residues and in tumultuous water. It is made with a double airtight chamber. Available with different types of cable. industrial waste with suspended agglomerate residues and in tumultuous water. It is made with a double airtight chamber. Available with different types of cable.

CÓDIGO	MEDIDA	€
CODE	SIZE	€
JPM0506BGO	5 m. CABLE PVC 3X1 μ20(8)	61,95
JPM1006BGO	10 m. CABLE PVC 3X1 μ20(8)	69,52
JPM2006BGO	20 m. CABLE PVC 3X1 μ20(8)	84,84
JPM0506BGO ATEX*	5 m. CABLE	71,12
JPM1006BGO ATEX*	10 m. CABLE	79,92

- * ATEX color negro
* ATEX black color
- Aguas sucias
Sewage

E-FLY

REGULADOR NIVEL AGUAS RESIDUALES
ELECTROMECHANICAL FLOAT SWITCHES FOR SEWAGE WATER

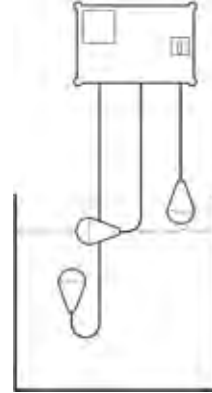

Aplicación: su cuerpo es más pequeño en tamaño, en comparación con Mac 5 y libre de protuberancias, adecuado para su uso en tanques pequeños para la eliminación de aguas residuales.

Ventajas: hecho con una cámara sellada doble y contrapeso incorporado en el cuerpo del flotador.

TAMBIÉN DISPONIBLE VERSIÓN ATEX CERTIFIED

Application: it has a body of a smaller size, compared to Mac 5, without harshness, suitable for use in small tanks for disposal of sewage water.

Advantages: made with a double liquid proof chamber and counterweight built into the body of the float.

ALSO AVAILABLE ATEX VERSION APPROVED

CÓDIGO	MEDIDA	€
CODE	SIZE	€
EPM0506B00	5 m. CABLE PVC 3X1 μ20(8)	61,95
EPM1006BG0	10 m. CABLE PVC 3X1 μ20(8)	69,52
EPM2006BG0	20 m. CABLE PVC 3X1 μ20(8)	84,84
EPM5060 ATEX*	5 m. CABLE	71,12
EPM10060 ATEX*	10 m. CABLE	79,92

- * ATEX color negro
- * ATEX black color

- Aguas sucias
Sewage

QUICK STOP

REGULADOR HIDRÁULICO DE CIERRE INMEDIATO
INSTANT CLOSURE HYDRAULIC REGULATOR



QuickStop es un regulador hidráulico de nivel patentado que elimina los típicos defectos de estos aparatos (flotadores mecánicos). Su característica principal es la rapidez para actuar en el sistema que pasa de abierto a cerrado y viceversa en una fracción de segundo, evitando el goteo en el llenado por restricción y disminuyendo sensiblemente el tiempo de llenado. Amplia gama desde 3/8" hasta 11/2". El mecanismo de regulación es muy simple y versátil y actúa sobre el ángulo de unión, así como la longitud e inclinación del brazo.

QuickStop is a hydraulic level regulator of advanced design that eliminates the classic defects of such devices (mechanical floats). Its main feature is the velocity of operation of the system which goes from open to closed and viceversa in a fraction of a second, avoiding long noise periods and the dripping due to choked filling. It's available in a wide range of models, from 3/8" to 11/2". The mechanism of regulation is very simple, it operates on then angle of the joint and the length and angle of the arm.

CÓDIGO	MEDIDA	€
CODE	SIZE	€
QS0000BR09 *	3/8"	11,16
QS0000BR12 *	1/2"	11,90
QS0000BR18 **	3/4"	18,60
QS0000BR25**	1"	19,34
QS0000BR32**	1 1/4"	22,95
QS0000BR40**	1 1/2"	28,48

- *Blanco/White
** Negro /Black
- Presión máxima 6 BAR
Maximum pressure 6 BAR



SUPER SIMPLEX E

REGULADOR DE PRESURIZACIÓN ELECTRÓNICO PARA BOMBAS / ELECTRONIC CONTROL SYSTEM OF ONE PUMP FOR PRESSURIZATION OF THE WATER



SuperSimplex E es un presostato muy versátil que le permite ajustar la presión de arranque entre 0,8 a 2 bares a través de un mando frontal y un manómetro de presión en el dispositivo. Desde fábrica se suministra ajustado a 1,5 bar.

SuperSimplex E, versión electrónica con la protección de funcionamiento en seco y reinicio automático.

The SuperSimplex E electronic pump regulator is a very versatile device that allows to adjust the restart pressure from 0,8 to 2 bar and through an external front handle and pressure gauge. It comes preset to 1,5 bar.

SuperSimplex E, an electronic version, with dry running protection and automatic restart.

CÓDIGO	DESCRIPCIÓN	€
CODE	DESCRIPTION	€
VSPXE00G00	MOD.E1.5-8 BAR	76,10

- Potencia máxima de la bomba 2HP monofásica
Maximum power pump 2HP single phase

SUPER SIMPLEX M

REGULADOR DE PRESURIZACIÓN ELECTROMECÁNICO PARA BOMBAS / ELECTROMECHANICAL CONTROL SYSTEM OF ONE PUMP FOR PRESSURIZATION OF THE WATER



SuperSimplex M, versión electrónica con entrada para un flotador de mínima. Permite ajustar la presión de arranque entre 0,8 a 2 bares a través de un mando. Con la apertura de una válvula/grifo, la presión cae por debajo del umbral de reinicio y el SuperSimplex activa la bomba. Cuando el usuario cierra el flujo de agua el SuperSimplex detiene la bomba después de un retardo adecuado.

SuperSimplex M, electromechanical pump regulator, with for a floating minium input. Opening a tap the pressure drops below the restart threshold and Super Simplex activates the pump, when the user closes the flow SuperSimplex stops the pump, after an ap-propiate delay.

CÓDIGO	DESCRIPCIÓN	€
CODE	DESCRIPTION	€
VSPXM00G00	MOD.M1.5-8 BAR	47,95

- Potencia máxima de la bomba 2HP monofásica
Maximum power pump 2HP single phase

SUPER SIMPLEX E

RECAMBIO - SUPERSIMPLEX E
SPARE PART - SUPERSIMPLEX E



CÓDIGO	DESCRIPCIÓN	€
CODE	DESCRIPTION	€
VS00E00G000	230V	34,40

MAC PRESS

PRESOSTATO PARA SISTEMAS DE PRESURIZACIÓN
PRESSURE SWITCH FOR PRESSURIZATION SYSTEMS



El MacPress es la gama de presostato de MAC3. El dispositivo viene calibrado de fábrica con una presión de ajuste que se puede cambiar a través del sistema de control interno. La instalación del MacPress se realiza directamente en el tubería mediante una conexión hembra de 1/4". Está disponible para bombas tanto monofásicas como trifásicas en las dos versiones de alta y baja presión.

MacPress is a pressure switches of MAC3. The device comes with a factory set pressure setting that can be changed using the internal regulating system. Macpress is installed directly on the pipe through a coupling by 1/4". The device is available for both single and three phase pumps in two versions for high and low pressure.

CÓDIGO	MEDIDA	€
CODE	SIZE	€
VPRM030000	M RANGO/RANGE 1,5-6,0 BAR MONOFÁSICO/SINGLE PHASE	12,36
VPRT030000	T RANGO/RANGE 1,5-6,0 BAR TRIFÁSICO/THREE PHASE	14,60

E POWER

VARIADOR DE VELOCIDAD VARIABLE FREQUENCY DRIVE

Los inversers de Mac3 son controladores variadores de frecuencia (VFD...), especialmente desarrollados para actuar sobre de bombas monofásicas y trifásicas.

En un sistema hidráulico la demanda de caudal máximo es ocasional y, de hecho, existen a menudo extracciones de agua no simultáneas, por lo que la demanda de caudal es variable, de modo que la bomba, generalmente, necesita trabajar con una velocidad variable en lugar de una velocidad fija (como en los sistemas tradicionales), de manera que el dispositivo trabajará a velocidad moderada con un bajo consumo de energía.

En los sistemas dinámicos de fluidos la relación entre potencia absorbida y la velocidad es de tipo cúbico, de modo que con un menor consumo de ciclos (Hz) se traduce en un alto ahorro energético.

Además del ahorro en el consumo de energía que genera el VDF, el VDF es importante para los fabricantes de sistemas de presión, ya que se traduce en economía de costes, además de otras ventajas importantes en términos de confort, rendimiento y durabilidad, que superan a los equipos tradicionales con vasos de presión. La instalación se realiza directamente en la tubería, ya que se refrigera por agua y el dispositivo tiene un sensor de presión integrado.

El dispositivo presenta una entrada ON/OFF para encender o apagar la bomba por medio de un flotador de mínima o interruptor y un relé de salida de contacto seco que puede ser usado como una señal de alarma o para impulsar un sistema para ensamblar grupos con una segunda bomba a velocidad fija.

Mac3 inverters are VFD variable frequency drivers, specially projected for driving pumps. In a water supply system, the demand of maximum delivery is occasional, and in fact there is often the need for variable delivery rates, so that the pump usually needs to operate at a variable delivery rate, rather than at a fixed rate (as in the case of traditional systems) so that the same will work at rates for most of the time with low energy consumption. In fluid dynamic systems the ratio between the absorbed power and speed is of cubic type; so that only a few less Hz translates into a much lower Kw consumption.

VFD's boosting systems, in addition to energy savings, for the customer translates into a cost economics, bring other important advantages in terms of confort, performance and durability of the system. The installation is directly on the pipe, cooled by water and the device has a built-in-pressure sensor.

The device has an ON/OFF input for a float switch and an output contact relay that can be used as a warning signal or to built boosting system with a second pump at a fixed rate.



CÓDIGO	MEDIDA	€
CODE	SIZE	€
VEPR1130000	PARA BOMBA MONOFÁSICA FOR SINGLE PHASE PUMP 230V 50-60HZ (E-MM08)	495,12
VEPR2120000	PARA BOMBA TRIFÁSICA THREE PHASE 230V 50-60HZ (E-MT10)	495,12

- Potencia máxima de la bomba monofásica 1,5HP
Maximum power of 1.5 HP for single phase pump
- Potencia máxima de la bomba trifásica 3HP
Maximum power of 3 HP for three phase pumpV

HYDRO CONTROLLER

Los Inverters Hydrocontroller fueron específicamente para el manejo de electrobombas, tanto monofásicas tradicionales (con condensador de arranque) como trifásicas.

Garantizan una presión constante al variar el caudal, ofreciendo al usuario el beneficio de un suministro de agua constante (Independientemente del número de servicios o llaves de agua), con un buen ahorro energético. Se ha prestado especial atención en la interfaz con el usuario para permitir una rápida y fácil instalación. El panel frontal dispone de 4 botones y una pantalla de 2 líneas x 16 caracteres para la operación y para la visualización de los parámetros de funcionamiento y de alarma.

Los parámetros se escriben en su totalidad en la pantalla y no hay una necesidad de consultar el manual para localizar e interpretar. Los parámetros para la puesta en marcha son principalmente la presión deseada y la corriente máxima de la bomba. En caso de condiciones anormales el HydroController protege el sistema de presión apagando la bomba, pero, para garantizar el suministro, hace intentos de restauración automática o programable. Se dispone de una amplia gama profesional para todas las necesidades.

La gama de los Hydrocontroller se divide en los siguientes modelos:

HCW para instalación directa en tuberías, refrigeración por agua y con sensor de presión y de flujo incorporado.

HCA para instalaciones en la pared, refrigeración por aire movido con ventilador y sensor de presión externo de serie.

Disponibles en las siguientes versiones:

Estándar

Versión básica que incluye todas las características y protecciones habituales, regula de modo continuo la velocidad de rotación de la electrobomba, a fin de mantener constante la presión al variar el caudal. Cada dispositivo permite el control de una sola electrobomba.

El dispositivo presenta una entrada ON/OFF para encender o apagar la bomba por un flotador de nivel mínimo o interruptor y un relé de salida de contacto en seco que se puede usar como señal de alarma o para crear grupos con una segunda bomba de velocidad fija.

Avanzada

Le añade a la versión básica una serie de funciones permitiendo la creación de grupos de bombeo de hasta 8 electrobombas (todas ellas han de ser idénticas). En la modalidad multibomba, la comunicación se realiza con protocolo canbus y cada electrobomba se controla y regula con un Hydro-Controller.

Con esta configuración, el sistema controla todas las electrobombas usadas a velocidad variable, incrementando / disminuyendo al tiempo su velocidad de rotación, a fin de mantener constante la presión al variar el caudal.

La alternancia de las electrobombas está asegurada y, en caso de fallo de un componente del grupo, el sistema se reconfigura automáticamente. En la versión Avanzada se han incorporado también las siguientes funciones:

Riego: puede ser conectado al HC a través del Multipress4, con la posibilidad de configurar hasta 4 presiones para distintas áreas de riego.

Hay disponibles 4 entradas de alimentación a 24V AC/DC.

2 salidas de contacto en seco (versiones MM y MT)

2 entradas auxiliares (versiones MM y MT).

Una entrada para flotador de mínima o interruptor que deja la bomba en standby.

Una salida de contacto seco para señal de alarma para poner la segunda bomba en ON/OFF. Los usos específicos de las entradas y salidas se pueden acordar con nuestra oficina técnica.

Hydrocontroller have been specifically developed to manage electro-pumps both single phase (with starter condenser) and three-phase. They guarantee a constant pressure despite capacity. Special attention has been addressed to the User Interface to allow a quick and easy installation through the messages displayed there is no need to consult the manual to locate and the interpret the parameters.

The parameters for the operation are the desired pressure and maximum current of the pump. In the event of an anomaly situation HydroController protects the pump as it switches off, but in order to safeguard the water supply it will undertake repeated automatic or programmed reset attempts. A wide range of models covering all the needs.

The range of Hydrocontroller is divided into the following models:

HCW for in line installation, cooled by water with built-in pressure sensor and flow sensor.

HCA for wall mounting installation, cooled by air, external pressure sensor provided as standard. Available following versions;

Standard

This version includes all the features and common protections that continuously regulates the rotation speed of the electro-pump so as to ensure a pressure despite varying flow. Each device allows to control a single pump.

The device has an input for external float switch, output relay that can be used as a warning signal or to built boosting system with a second pump at a fixed rate.

Advanced

More than the basic version, this model adds more features and allows the realization of the groups up to 8 pumps (all pumps must be identical). In the multi-pumps mode, the communication is CanBus protocol and each pump is controlled and regulated by a Hydrocontroller.

In this configuration, the system handles all the pumps used in variable speed, increasing/ decreasing together their speeds of rotation, in order to keep the pressure constant at the flow rate varies.

The alternation of the pumps is guaranteed and in case of failure of a component of the system automatically it until reconfigures itself. The advanced version also integrates the following features:

Irrigation: the irrigation control unit can be connected to the HC through the MultiPress4, with the possibility of setting up to 4 pressures, for different sectors of irrigation. there are 4 inputs to be supplied at 24V ac/dc.

Outputs relays (MM and MT versions).Auxiliary inputs (MM and MT versions).

One input for floating minimum or a switch into standby mode the pump.

One output relay for alarm or to control a second pump at fixed rate. Specific uses of the inputs and outputs can be arranged with our technical department.

HYDRO CONTROLLER HCW-MM

ALIMENTACIÓN MONOFÁSICA PARA ELECTROBOMBA MONOFÁSICA
SINGLE PHASE POWER SUPPLY FOR SINGLE PHASE PUMPS

CÓDIGO	MEDIDA	€
CODE	SIZE	€
VHDR1130000A	STAND. (1P) 1.5Hp AGUA/WATER 8A	635,84
VHDR1140000A	STAND. (1P) 2.2Hp AGUA/WATER 12A	766,13

- Consultar plazo de entrega
Advice with delivery time



HYDRO CONTROLLER HCW-MT HCA-MT

ALIMENTACIÓN MONOFÁSICA PARA ELECTROBOMBA TRIFÁSICA
SINGLE PHASE POWER SUPPLY FOR THREE PHASE PUMPS

CÓDIGO	MEDIDA	€
CODE	SIZE	€
VHDR2420000	ADV. (3P) 3Hp AGUA/WATER 10A	740,08
VHDA2420000	ADV. (3P) 3Hp AIRE/AIR 10A	875,58

- Consultar plazo de entrega
Advice with delivery time



HYDRO CONTROLLER HCW-TT HCA-TT

ALIMENTACIÓN TRIFÁSICA PARA ELECTROBOMBA TRIFÁSICA
THREE PHASE POWER SUPPLY FOR THREE PHASE PUMPS



CÓDIGO	MEDIDA	€
CODE	SIZE	€
VHDR3110000	STAND. (3P) 3Hp AGUA/WATER 6A	985,03
VHDR3120000	STAND. (3P) 5,5Hp AGUA/WATER 11A	1.039,75
VHDR3410000	ADV. (3P) 3Hp AGUA/WATER 6A	1.094,48
VHDR3420000	ADV. (3P) 5.5Hp AGUA/WATER 11A	1.149,20
VHDA3120000B	STAND. (3P) 5.5Hp AIRE/AIR 11A	1.203,93
VHDA3420000	ADV. (3P) 5.5Hp AIRE/AIR 11A	1.318,59
VHDA3430000	ADV. (3P) 7.5Hp AIRE/AIR 15A	1.511,42

- Consultar plazo de entrega
Advice with delivery time

ELECTRO SONDA Q

ELECTROSONDA Q
Q ELECTROPROBE



De sensibilidad alta, baja y variable para la barra DIN. Las electrosondas producidas por Mac3 de la serie Q son reguladores para líquidos conductores, aptas para controlar el nivel mínimo y máximo en pozos profundos, tanques, cisternas, etc.

Su funcionamiento se basa en la detección del líquido por parte de la unidad de control de la resistencia del líquido, cuyo nivel se controla por medio de sondas apropiadamente colocadas en el mismo, de las cuales la más larga actúa como común. Cuando el nivel del líquido dentro del recipiente o del pozo moja las tres sondas sumergidas se activa inmediatamente el relé, y se desactiva tan sólo en el momento en que desciende el nivel, dejando al descubierto la sonda baja.

At high, low and variable sensitivity for DIN rail. The electroprobes of the Q series produced by Mac3 are regulators of conductive fluid suitable for the minimum and maximum level control of deep well, tanks, cisterns etc. The operating principle is based on the detection of the fluid resistance on the part of the control box, the level being controlled by means of special probes immersed in the liquid with the longest acting as a common element.

When the level of the liquid inside the container or the well wets all three probes a relay is activated and subsequently deactivated only when the level descends, uncovering the lower probe.

CÓDIGO	MEDIDA	€
CODE	SIZE	€
EQ3SC01000	NORMAL 5,6K (230V)	39,40
EQ3SC01003	NORMAL 5.6K (230V) + 3 SONDAS	63,86

SONDA

SONDA PARA ELECTROSONDA
PROBE FOR ELECTROPROBE



Mat. ABS + AISI 316 Temperatura máxima 80°C, accesorio para líquidos conductivos.

Mat. ABS + AISI 316. Maximum temperature 80°C, accessory for conductive liquids.

CÓDIGO	MEDIDA	€
CODE	SIZE	€
TSOND00000	SONDA PARA ELECTROSONDA	8,24

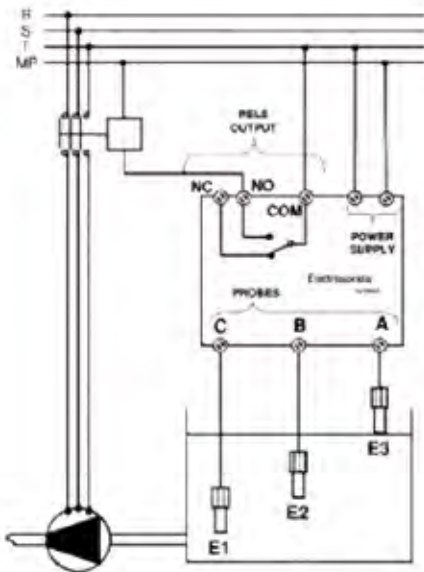

EMPTING

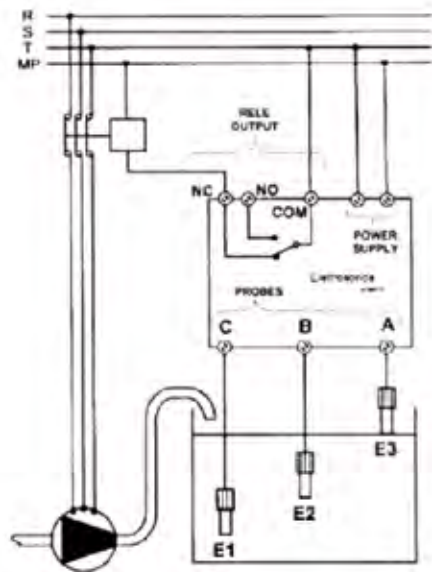

FILLING

SISTEMAS DE PRESURIZACIÓN BOOSTING SYSTEMS



AGUAS SUCIAS SEWAGE

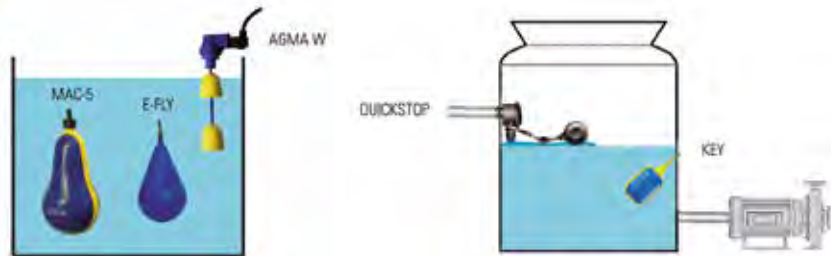

POZOS Y ALJIBES WELLS AND CISTERNS



PANEL DE CONTROL CONTROL PANEL





STOP FLOW

DETECTOR Y DISYUNTOR DE FUGAS DE AGUA
WATER LEAKAGE DETECTOR AND CIRCUIT BREAKER



El Stop Flow es un dispositivo autónomo (sin conexión a la corriente) que está vigilando la instalación de suministro de agua constantemente y es capaz de detectar una fuga y cortar el suministro de agua a la vivienda para evitar desperfectos y pérdidas de agua.

Stop Flow is an autonomous device (without connection to the current) that is constantly monitoring the water supply installation and it is capable of detecting a leak and cutting off the water supply to house to avoid damages and water losses.

CÓDIGO	€
CODE	€
STF20	1 Consultar



CÓDIGO	€
CODE	€
STFC0*	1 Consultar

- Conexión wifi
Wifi connection

Para medidas mayores y otras aplicaciones en edificación consultar (hoteles, escuelas, edificios de oficinas, estaciones de tren, oficinas bancarias, centros comerciales, etc.)

For larger measures and other applications in building consult (hotels, schools, office buildings, train stations, bank offices, shopping centers, etc.)

REDUCTORAS DE PRESIÓN

PRESSURE REDUCING VALVE

4150



REDUCTORA DE PRESIÓN "MIGNON"
PRESSURE REDUCING VALVE 'MIGNON'



CÓDIGO	MEDIDA			€
CODE	SIZE			€
4150-015	1/2"	50	1	20,59
4150-020	3/4"	50	1	21,55

- Presión máxima de entrada 15 Bar / Latón DZR opcional
Maximum admission pressure 15 Bar / Optional in brass DZR

4151



REDUCTORA DE PRESIÓN
PRESSURE REDUCING VALVE



CÓDIGO	MEDIDA			€
CODE	SIZE			€
4151-015	1/2"	30	1	35,76
4151-020	3/4"	30	1	51,38
4151-025	1"	15	1	64,21
4151-032	1 1/4"	6	1	121,45
4151-040	1 1/2"	6	1	142,49
4151-050	2"	3	1	217,88
4151-065	2 1/2"	3	1	315,57
4151-080	3"	3	1	452,70

- Presión máxima de entrada 25 Bar / Latón DZR opcional
Maximum admission pressure 25 Bar / Optional in brass DZR

4152



REDUCTORA DE PRESIÓN CON
RACORES
PRESSURE REDUCING VALVE
WITH RACORDS



CÓDIGO	MEDIDA			€
CODE	SIZE			€
4152-015	1/2"	20	1	45,24
4152-020	3/4"	10	1	73,52
4152-025	1"	10	1	79,35
4152-032	1 1/4"	6	1	151,73
4152-040	1 1/2"	6	1	164,04
4152-050	2"	3	1	268,77

- Presión máxima de entrada 25 Bar / Latón DZR opcional
Maximum admission pressure 25 Bar / Optional in brass DZR

4153



REDUCTORA DE PRESIÓN CON
BRIDAS
PRESSURE REDUCING VALVE
FLANGED ENDS



CÓDIGO	MEDIDA			€
CODE	SIZE			€
4153-050	2"	2	1	1.338,56
4153-065	2 1/2"	2	1	1.539,07

- Presión máxima de entrada 25 Bar / Latón DZR opcional
Maximum admission pressure 25 Bar / Optional in brass DZR

4154



REDUCTORA DE PRESIÓN CON GRADUACIÓN
PRESSURE REDUCING VALVE WITH GRADUATED SETTING



CÓDIGO	MEDIDA			€
CODE	SIZE			€
4154-015	1/2"	15	1	98,58
4154-020	3/4"	15	1	107,54
4154-025	1"	10	1	139,04

- Presión máxima de entrada 25 Bar
Maximum admission pressure 25 Bar

4155



REDUCTORA DE PRESIÓN CON RACORS Y GRADUACIÓN
PRESSURE REDUCING VALVE WITH RACORDS AND GRADUATED SETTINGS



CÓDIGO	MEDIDA			€
CODE	SIZE			€
4155-015	1/2"	15	1	111,51
4155-020	3/4"	10	1	136,13
4155-025	1"	10	1	151,69

- Presión máxima de entrada 25 Bar
Maximum admission pressure 25 Bar

4160



FILTRO Y DISPOSITIVO ANTIREFLUJO (TAMIZ DE 100µ)
FILTERS AND BACKFLOW PREVENTER (100µ)



CÓDIGO	MEDIDA			€
CODE	SIZE			€
4160-015	1/2"	20	1	112,65
4160-020	3/4"	20	1	112,65
4160-025	1"	18	1	137,51
4160-032	1 1/4"	10	1	137,51
4160-040	1 1/2"	10	1	168,55
4160-050	2"	6	1	168,55

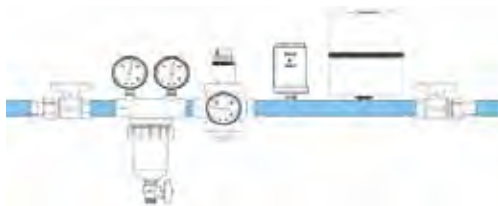

4161



AMORTIGUADOR GOLPE DE ARIETE
WATER HAMMER ARRESTOR



CÓDIGO	MEDIDA			€
CODE	SIZE			€
4161-015	1/2"	20	1	26,82

- Hasta tubería de 50mm.
Up to 50mm. pipe

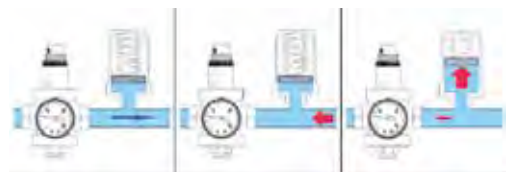

4156



FILTRO MAGNÉTICO MAGNETIC STRAINER

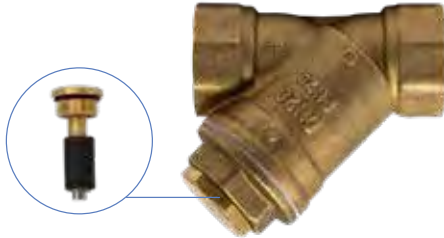

CÓDIGO CODE	MEDIDA SIZE			€ €
4156-020	3/4"	50	1	55,90
4156-025	1"	50	1	64,29

ELIMINA LAS IMPUREZAS DE LOS CIRCUITOS.
EL IMÁN QUE INCORPORA RETIENE LAS IMPUREZAS FÉRRICAS.
REMOVES IMPURITIES FROM THE CIRCUITS.
THE INCORPORATING MAG NET RETAINS THE IRON IMPURITIES.

- Tamiz filtrante de 1000 micras (1mm)
Filter sieve 1000 microns (1mm)
- Imán extraíble de 3.000 Gauss
3.000 Gauss removable magnet
- Roscas hembra según ISO 228
Female threads according to ISO 228
- Fácil desmontaje del tamiz para su limpieza con junta de PTFE
Easy disassembly of the sieve for cleaning with PTFE gasket.
- Presión máxima de trabajo: 10 Bar
Max. working pressure: 10 Bar
- Temperatura de funcionamiento de 130°C
Operating temperature of 130°C

Apto para instalaciones de calefacción con calderas de gas, gasoil y biomasa. Instalaciones de calor y frío con bomba de calor de aero termia y geotermia. Instalaciones de agua y agua con glicol. Instalaciones de suministro de agua.
Suitable for heating installations with gas, diesel and biomass boilers. Heat and cold installations with aerothermal and geothermal heat pump. Water and water installations with glycol. Water supply facilities.

4157



FILTRO DESFANGADOR MAGNÉTICO MAGNETIC DIRT SEPARATOR STRAINER



CÓDIGO CODE	MEDIDA SIZE			€ €
4157-020	3/4"	5	1	111,35

SEPARA Y ELIMINA LAS IMPUREZAS DE LOS CIRCUITOS CERRADOS. EL IMÁN QUE INCORPORA RETIENE LAS IMPUREZAS FÉRRICAS.

SEPARATES AND REMOVES IMPURITIES FROM CLOSED CIRCUITS. THE INCORPORATING MAGNET RETAINS THE IRON IMPURITIES.

- Tamiz filtrante de 800 micras (0.8mm)
Filter sieve 800 microns (0.8mm)
- Imán extraíble de 12.000 Gauss
12.000 Gauss removable magnet
- Válvula M-H de 3/4", enlace 3/4" (racor loco) y tapón 3/4" en latón
M "M-H valve, 3/4" link (crazy fitting) and brass 3/4" plug
- Roscas hembra según ISO 228
Female threads according to ISO 228
- Fácil desmontaje del tamiz para su limpieza con junta de PTFE
Easy disassembly of the sieve for cleaning with PTFE gasket.
- Presión máxima de trabajo: 10 Bar
Max. working pressure: 10 Bar
- Temperatura de funcionamiento de 110°C
Operating temperature of 110°C
- Ideal para instalación en lugares con limitaciones de espacio.
Ideal for installation in places with space limitations.
- Con la instalación de una válvula en el tapón se puede limpiar las impurezas del desfangador sin parar el circuito.
With the installation of a valve in the cap, the impurities of the defroster can be cleaned without stopping the circuit.

Apto para instalaciones de calefacción con calderas de gas, gasoil y biomasa. Instalaciones de calor y frío con bomba de calor de aero termia y geotermia. Instalaciones de agua y agua con glicol.
Suitable for heating installations with gas, diesel and biomass boilers. Heat and cold installations with aerothermal and geothermal heat pump. Water and water installations with glycol.

VÁLVULAS DE BOLA

BALL VALVES

1010

VÁLVULA DE BOLA EN PVC
PARA ENCOLAR
PVC BALL VALVE SOCKET
ENDS



CÓDIGO	MEDIDA			€
CODE	SIZE			€
1010-25	25 mm.	40	1	8,95
1010-32	32 mm.	40	1	10,99
1010-40	40 mm.	16	1	14,03
1010-50	50 mm.	16	1	17,37
1010-63	63 mm.	10	1	24,62
1010-75	75 mm.	3	1	99,51
1010-90	90 mm.	3	1	139,72

- Presión máxima de trabajo: 10 Bar
- Working pressure (Max): 10 Bar

101010

VÁLVULA DE BOLA EN PVC
PARA ROSCAR
PVC BALL VALVE THREADED
ENDS



CÓDIGO	MEDIDA			€
CODE	SIZE			€
101010-25	3/4"	40	1	9,49
101010-32	1"	40	1	12,43
101010-40	1 1/4"	16	1	14,71
101010-50	1 1/2"	16	1	18,87
101010-63	2"	10	1	25,50
101010-75	2 1/2"	3	1	100,70
101010-90	3"	3	1	144,10

- Presión máxima de trabajo: 10 Bar
- Working pressure (Max): 10 Bar

2510 PASO T

VÁLVULA DE BOLA TRES
VÍAS EN PVC PASO T PARA
ENCOLAR
T PVC THREE WAY BALL VALVE
PORT SOCKET ENDS



CÓDIGO	MEDIDA			€
CODE	SIZE			€
2510-016	16 mm.	40	1	28,93
2510-020	20 mm.	40	1	28,93
2510-025	25 mm.	28	1	35,50
2510-032	32 mm.	36	1	43,37
2510-040	40 mm.	22	1	52,63
2510-050	50 mm.	12	1	67,75
2510-063	63 mm.	10	1	81,20

- Presión máxima de trabajo: 10 Bar
- Working pressure (Max): 10 Bar

2510 PASO L

VÁLVULA DE BOLA TRES
VÍAS EN PVC PASO L PARA
ENCOLAR
L PVC THREE WAY BALL VALVE
PORT SOCKET ENDS



CÓDIGO	MEDIDA			€
CODE	SIZE			€
2510-017	16 mm.	40	1	28,93
2510-021	20 mm.	40	1	28,93
2510-026	25 mm.	28	1	35,50
2510-033	32 mm.	36	1	43,37
2510-041	40 mm.	22	1	52,63
2510-051	50 mm.	12	1	67,75
2510-064	63 mm.	10	1	81,20

- Presión máxima de trabajo: 10 Bar
- Working pressure (Max): 10 Bar

FLEXO DE DUCHA

SHOWER HOSE

600



FLEXO DE DUCHA EN ACERO
INOXIDABLE DOBLE ENGATI-
LLADO
SHOWER STAINLESS STEEL
HOSE DOUBLE CLIP



CÓDIGO	MEDIDA			€
CODE	SIZE			€
600-02	1/2"	50	1	6,31

- Longitud 170-210mm.
Length 170-210mm.

6002



FLEXO DE DUCHA EN
ACERO INOXIDABLE DOBLE
ENGATILLADO CONECTORES
PLÁSTICO
SHOWER STAINLESS STEEL
HOSE DOUBLE CLIP PLASTIC
CONNECTORS



CÓDIGO	MEDIDA			€
CODE	SIZE			€
6002-02	1/2"	50	1	3,60

- Longitud 170-210mm.
Length 170-210mm.

FH304



MANGUERA FLEXIBLE CORRUGADA DE ACERO INOXIDABLE
FLEXIBLE CORRUGATED
STAINLESS STEEL HOSE



CÓDIGO	MEDIDA			€
CODE	SIZE			€
FH304-01005	3/8" x 5 m.	10	1	35,54
FH304-01010	3/8" x 10 m.	10	1	70,04
FH304-01510	1/2" x 10 m.	10	1	91,93

- Disponible hasta agotar existencias
While stocks lasts

601



FLEXO DE DUCHA FLEXIBLE PVC
FLEXIBLE PVC SHOWER HOSE



CÓDIGO	MEDIDA			€
CODE	SIZE			€
601-02	1/2"	40	1	7,30

- Longitud 175mm.
Length 175mm.

RL901



RACOR DE LATÓN PARA TUBO CORRUGADO
FITTING FOR CORRUGATED HOSE



CÓDIGO	MEDIDA			€
CODE	SIZE			€
RL901-010	3/8"	1	1	2,51
RL901-015	1/2"	1	1	4,00
RL901-020	3/4"	1	1	5,78

VÁLVULAS DE DESCARGA Y LLENADO

FLUSH AND FILL VALVES



Un exclusivo expositor para poder ofrecer una mejor presentación en sus válvulas de llenado y descarga

An exclusive exhibitor can be offered together with flush and fill valves for better presentation

55007



VÁLVULA DE LLENADO ALIMENTACIÓN MIXTA
MIXED FILL VALVE



CÓDIGO	MEDIDA			€
CODE	SIZE			€
55007	3/8"	24	1	18,75

55002



VÁLVULA DE LLENADO
ALIMENTACIÓN INFERIOR
BOTTOM FILL VALVE



CÓDIGO	MEDIDA			€
CODE	SIZE			€
55002	3/8"	25	1	16,87

55003



VÁLVULA DE LLENADO
ALIMENTACIÓN LATERAL
SIDE FILL VALVE



CÓDIGO	MEDIDA			€
CODE	SIZE			€
55003	3/8"	24	1	16,34

55006



VÁLVULA DE DESCARGA
DE DOBLE PULSADOR
DUAL FLUSH VALVE



CÓDIGO	MEDIDA			€
CODE	SIZE			€
55006	2"	25	1	26,30

- Tornillos de fijación incluidos
Tank fastening screws included
- Compatible con las principales marcas de sanitarios
Suitable for the main sanitary brands

55001



VÁLVULA DE DESCARGA
DE DOBLE PULSADOR CON CABLE
CABLE DUAL FLUSH VALVE



CÓDIGO	MEDIDA			€
CODE	SIZE			€
55001	2"	25	1	26,99

- Tornillos de fijación incluidos
Tank fastening screws included

55004



VÁLVULA DE DESCARGA
DE PULSADOR SIMPLE
SINGLE FLUSH VALVE



CÓDIGO	MEDIDA			€
CODE	SIZE			€
55004	2"	25	1	24,66

- Tornillos de fijación incluidos
Tank fastening screws included

55005



VÁLVULA DE DESCARGA
DE DOBLE PULSADOR CON
CABLE ADAPTADOR UNIVERSAL
CABLE DUAL FLUSH VALVE
UNIVERSAL ADAPTOR



CÓDIGO	MEDIDA			€
CODE	SIZE			€
55005	2"	20	1	29,93

- Tornillos de fijación incluidos
Tank fastening screws included

55015



RECAMBIO - JUNTA Y TORNILLOS
SPARE PART - FLAT GASKET AND BOLTS



CÓDIGO				€
CODE				€
55015		150	1	4,83

- Tornillos de acero inoxidable
Stainless steel screws

ADHESIVOS

ADHESIVES

THF ALTA PRESIÓN

THF ALTA PRESIÓN ULTRARÁPIDO
THF ULTRAFAST HIGH PRESSURE



CÓDIGO	PRODUCTO		€
CODE	PRODUCT		€
IT00101	TUBO 125 ml.	25	3,38
IT00103	BOTE 500 ml.	24	11,52
IT00104	BOTE 500 ml. + PINCEL	24	12,60
IT00105	BOTE 1.000 ml.	12	20,07
IT00106	BOTE 1.000 ml. + PINCEL	12	20,91

- Tiempo de secado 30 segundos
- 30 secons dry
- Adhesivo PVC
- PVC cement

N-30 SECADO RÁPIDO

N-30 "PRESIÓN" SECADO RÁPIDO
N-30 'PRESSURE' FAST CURING



CÓDIGO	PRODUCTO		€
CODE	PRODUCT		€
IT00301	TUBO 125 ml.	25	2,22
IT00302	BOTE 250 ml. + PINCEL	24	5,46
IT00304	BOTE 500 ml. + PINCEL	24	8,97
IT00306	BOTE 1.000 ml. + PINCEL	12	15,27

- Tiempo de secado 90 segundos
- 90 secons dry
- Adhesivo PVC
- PVC cement

N-40 SECADO LENTO

N-40 "PRESIÓN"
SECADO LENTO
N-40 'PRESSURE'
SLOW CURING



CÓDIGO	PRODUCTO		€
CODE	PRODUCT		€
IT00401	TUBO 125 ml.	25	1,91
IT00404	BOTE 500 ml. + PINCEL	24	7,55
IT00406	BOTE 1.000 ml. + PINCEL	12	11,52

- Tiempo de secado 180 segundos
- 180 secons dry
- Adhesivo PVC
- PVC cement

BLUETITE PVC FLEXIBLE

BLUETITE ADHESIVO
PVC FLEXIBLE
BLUETITE SOLVENT
CEMENT PVC FLEXIBLE



CÓDIGO	PRODUCTO		€
CODE	PRODUCT		€
IT00201	TUBO 125 ml.	25	2,86
IT00202	BOTE 250 ml. + PINCEL	24	7,00
IT00204	BOTE 500 ml. + PINCEL	24	11,40
IT00206	BOTE 1.000 ml. + PINCEL	12	18,59

- Adhesivo PVC
- PVC cement

LN-40

LN-40 LIMPIADOR PARA PVC
(DECAPANTE)
LN-40 CLEANER FOR PVC
(STRIPPER)



CÓDIGO	PRODUCTO		€
CODE	PRODUCT		€
IT00802LNP*	BOTE 250 ml.	24	3,69
IT00803LN	BOTE 500 ml.	24	5,61
IT00805LN	BOTE 1.000 ml.	12	5,61

- Formato de plástico
- Plastic format

LIMPIADOR

LIMPIADOR POLIETILENO
POLYETHYLENE CLEANER

NEW



CÓDIGO	PRODUCTO		€
CODE	PRODUCT		€
IT00805IPA	BOTE 1.000 ml.	12	8,81

PTFE LÍQUIDO

PTFE LÍQUIDO
LIQUID PTFE



CÓDIGO	PRODUCTO		€
CODE	PRODUCT		€
IT013L75	75 ml.	12	5,61

- Sellado de roscas en fontanería
- Threaded seal in plumbing

CINTA PTFE

WRAS

CINTA DE PTFE
PTFE TAPE



CÓDIGO	MEDIDA			€
CODE	SIZE			€
700-10	12 x 12 x 0,075	1000	10	0,55
700-11	12 x 12 x 0,10	1000	10	0,70
700-12	25 x 15 x 0,10	250	10	1,69
700-13	50 x 19 x 0,10	250	10	4,20

DESATASCADOR

DESATASCADOR
DRAIN CLEANER



CÓDIGO	PRODUCTO		€
CODE	PRODUCT		€
IT00803DES	500 ml.	24	5,46
IT00805DES	1.000 ml.	12	8,67

SELLADOR

SELLADOR HIDRÁULICO BAJA
RESISTENCIA
HYDRAULIC SEALANT



CÓDIGO	PRODUCTO		€
CODE	PRODUCT		€
IT019142	50 ml.	10	10,57

CIANOCRILATO

CIANOCRILATO
CYANOACRYLATE



CÓDIGO	PRODUCTO		€
CODE	PRODUCT		€
IT019C	20 cc.	12	3,62

CONDICIONES DE VENTA

TERMS & CONDITIONS

CONDICIONES VÁLIDAS SÓLO PARA ESPAÑA VALID CONDITIONS ONLY IN SPAIN

PRECIOS Y CONDICIONES DE PAGO

Contado: reposición o recibo a 15 días dto. P.P. 1%.

Forma de pago: plazo máximo 60 días fecha factura.

IVA: se cargará el % correspondiente, según reglamentación en vigor.

Tarifas de precios: nos comprometemos a comunicar a nuestros clientes cualquier cambio que se produzca en las tarifas del catálogo a través de las usuales vías de comunicación: web, email, correo.

PEDIDOS

Con el fin de evitar confusiones y ofrecer un mejor servicio, será condición indispensable por parte del comprador indicar la referencia MT Business Key, S.L. en su pedido, incluidos los dígitos de la medida. Cada pedido enviado a MT Business Key, S.L. genera una expedición para el cliente, recomendamos que preparen sus pedidos completos para optimizar los gastos de transporte. Todos los pedidos serán confirmados vía email y, salvo notificación de lo contrario, seguirá su curso sin derecho a posteriores modificaciones.

Pedido mínimo aceptable: 150€ netos.

Cantidades mínimas: las cantidades mínimas aceptables corresponderán a las del embalaje interior de la caja.

Embalajes: incluidos.

PORTES

Se cargarán 7€ en factura para pedidos inferiores a los 400 € netos (Península y Baleares). Para el resto del territorio se cargarán los portes en factura aplicando la tarifa reducida de nuestra agencia de transportes.

España (Península) e Islas Baleares: incluidos en pedidos superiores a 400€ netos.

Melilla: incluidos en pedidos superiores a 1200€ netos.

Islas Canarias: incluidos en pedidos superiores a 800€ netos.

CONDICIONES VÁLIDAS SÓLO PARA EXPORTACIÓN VALID CONDITIONS ONLY FOR EXPORT

RATES AND FREIGHTS CONDITIONS

Cash: bank transfer. For advance payments discount 1%.

Credit: max. 60 days invoice date after Bank Insurance Approval.

Freight Conditions: EXW Incoterms 2010, unless other conditions are granted.

Price rates: MT Business Key, S.L. commits to communicate to our customers any changes applied on tariffs through usual means of communication: web & email.

ORDERS

Minimum order amount: 500€ netto.

Minimum quantities: the minimum acceptable quantities will be equal to inner packing quantities.

Packing: included.

CUSTOMER SERVICE

Claims: all claims will be granted within 45 days after date of Invoice. After this period MT Business Key, S.L. can't promise any resolution.

Warranty: all our products are new and are covered for 2 years.

Return policy: all material returned will be at freight paid. All products must be in original conditions and clearly identified. If after inspection in our warehouse these products are not in original condition, we might apply a devaluation fee.

SERVICIOS POSTVENTA OFRECIDOS POR MT:

Reclamaciones: cualquier reclamación deberá formularse dentro de los treinta (30) días siguientes a la fecha de factura, rechazándose las efectuadas después de dicho plazo límite.

Periodo de desistimiento: conforme la Ley General para la Defensa de los Consumidores y Usuarios, el comprador dispone de catorce (14) días naturales para devolver la totalidad o parte del pedido sin penalización alguna, a contar desde la fecha de factura.

Devoluciones: no se aceptará ninguna devolución de material sin antes existir la conformidad expresa, mediante el número de devolución facilitado, por la empresa (*véase nuestra política y proceso de devolución en la web*). El plazo máximo admitido para devolver material no conforme es de sesenta (60) días, a contar desde la fecha de factura.

Garantía: todos nuestros productos tienen 2 años de garantía según establece la Ley vigente. Si el defecto se manifiesta pasados los 6 meses después de su compra se requerirá una revisión técnica y/o pericial por nuestro departamento de calidad con tal de poder aplicar su derecho a la garantía.

La garantía queda limitada pura y simplemente al reemplazo de las piezas, una vez reconocidas materialmente defectuosas por nuestro personal técnico sin indemnización.

Litigios: en caso de litigio ambas partes aceptan someter sus diferencias a los juzgados y tribunales de Barcelona.

MT Business Key S.L. se reserva la facultad de cambiar en todo o en parte el diseño, materiales, embolsado, encajado y precios de cualquiera de sus productos.

CONDITIONS INSIDE EU:

Even though all purchases are covered by our extended 14-day exchange or refund promise, no material return will be accepted without the conformity of the commercial department.

No unwanted material returned will be accepted after 60 days invoice's date. All unwanted material returned after 14 days of date of invoice and before maximum period of acceptance (60 days) will be charged 30% of demerit.

CONDITIONS OUTSIDE EU:

No unwanted material returned will be accepted after 90 days Invoice's date. All unwanted material returned will be charged 30% of demerit.

Litigations: in case of litigation both sides agree to take their differences at the courts of Barcelona.

MT Business Key S.L. reserves the right to modify all or part of the design, materials, packing or prices of any of their products.



Nuevo servicio urgente 24 horas sólo para España

Para paquetería de menos de 10 kg. 7 € en factura.

Para expediciones de menos de 30 kg. 12 € en factura.

Para pedidos superiores a 30 kg de peso, consultar.

New urgent service 24 hours only in Spain

For packages of less than 10 kg. 7 € in invoice

For expeditions of less than 30 kg. 12 € in invoice

For higher orders to 30 kg weight, consult.

ÍNDICE DE REFERENCIAS

REFERENCES INDEX

REF	PAG	REF	PAG	REF	PAG
001	142	4103	28	4225	55
002	142	4104	22	4226	55
003	142	4105	30	4230	55
040	142	4106	27	4295	26
041	143	4107	29	4400	46
085	143	4108	29	4401	46
090	143	4109	51	4402	44
092	143	4110	51	4404	44
096	144	4111	38	4405	44
098	144	4113	52	4406	45
120	145	4114	52	4407	47
130	146	4115	53	4409	45
180	145	4116	53	4410	46
221	145	4117	53	4411	44
223	145	4118	54	4412	57
240	148	4119	54	4413	56
241	148	4120	54	4414	56
245	147	4121	41	4415	56
246	147	4122	41	4416	56
270	149	4123	39	4417	57
280	149	4124	30	4418	57
290	149	4125	38	4419	57
300	149	4141	40	4422	45
301	150	4142	38	4426	45
312	150	4143	39	4434	46
321	150	4144	38	4435	47
340	150	4145	40	4504	22
341	151	4146	39	4604	23
529	151	4147	39	6002	173
600	173	4148	40	6400	132
601	173	4149	40	6402	132
645	126	4150	169	6403	132
0921	41	4151	169	6601	115
1010	172	4152	169	6602	115
4091	34	4153	169	6603	115
4092	34	4154	170	6604	117
4093	35	4155	170	6606	117
4094	35	4156	171	6607	117
4097	26	4157	171	6608	118
4098	27	4160	170	6609	118
4099	30	4161	170	6610	118
4100	29 / 50	4204	23	6611	118
4100	29 / 96	4215	53	6612	119
4101	29 / 50	4221	30	6650	119
4101	29 / 96	4222	31	9991	103
4102	28	4224	55	40642	31

REF	PAG
40642	131
40912	34
40922	34
40932	35
40942	35
40972	26
40982	27
41022	28
41032	28
41062	27
41092	51
41102	51
41642	31
41642	131
42642	31
42642	132
42952	26
55001	175
55002	174
55003	174
55004	175
55005	175
55006	175
55007	174
55015	175
64015	125
64016	125
66005	117
66901	119
82130	75
82220	75
82270	75
86090	87
86092	87
86130	87
86180	87
86243	89
86270	89
86301	89
86361	90
86362	91
86363	91
86472	89
87001	64
87002	64
87090	64
87092	65
87093	65
87098	65
87130	65
87132	66

REF	PAG
87180	66
87240	66
87241	67
87245	67
87246	68
87270	68
87271	68
87280	68
87290	69
87300	69
87315	69
87318	69
87340	70
87341	70
87500	70
87529	71
87530	71
87531	71
87532	72
87533	71
87534	81
87550	72
87560	73
87561	73
87562	73
87563	72
87570	74
87575	72
88010	94
88030	94
88050	94
88090	94
88110	95
88130	95
88150	95
88170	95
88190	96
88500	96
88900	97
88901	97
88901	97
89022	105
89042	105
89062	105
89102	105
89122	107
89142	107
89162	107
89202	107
89359	90
89360	90

REF	PAG
89900	108
89902	108
97001	74
97091	111
97130	110
97131	110
97132	110
97270	110
97280	111
97900	74
98010	113
98020	113
98090	113
98110	113
99010	99
99020	99
99030	99
99050	99
99090	101
99110	101
99120	102
99130	101
99150	101
99170	102
99190	102
99500	102
99902	103
101010	172
228410	83
228420	83
228421	83
228431	85
449017	58
449117	58
492550	36
492552	36
493080	32
493082	32
494081	24
641090	122
641091	122
641092	122
641130	123
641131	123
641132	123
641133	123
641270	122
641271	124
641272	124
641273	124
641500	124

REF	PAG	REF	PAG
642090	128	41332G	136
642091	128	4133G	136
642092	128	4134G	136
642130	128	4135G	137
642131	129	4145G	139
642132	129	4147G	139
642133	129	4148G	138
642270	130	640B	126
642271	130	640R	126
642272	130	6601R	115
642273	130	87090R	64
642274	131	87130R	66
642500	131	AGMA	156
871090	78	BLUETITE PVC FLEXIBLE	177
871092	78	CIANOCRILATO	179
871130	78	CINTA PTFE	178
871240	79	DESATASCADOR	178
871241	79	E POWER	161
871245	79	E-FLY	157
871246	79	ELECTRO SONDA Q	165
871270	80	FH304	173
871280	80	HYDRO CONTROLLER HCW-	163
871290	80	MM	
871300	80	HYDRO CONTROLLER HCW-	163
871500	78	MT HCA-MT	
871529	81	HYDRO CONTROLLER HCW-TT	164
871531	81	HCA-TT	
873412	70	KEY	155
889901	97	LIMPIADOR	177
889901	103	LN-40	177
170811010	60	MAC PRESS	160
170811015	61	MAC3	155
170811510	61	MAC5	156
170811515	61	MAP115MLS4	133
170821010	60	N-30 SECADO RÁPIDO	176
170821015	60	N-40 SECADO LENTO	177
170821515	60	PTFE LÍQUIDO	178
090R	144	QUICKSTOP	158
0921G	138	RL901	173
130R	146	SELLADOR	178
2510 PASO L	172	SONDA	166
2510 PASO T	172	STOP FLOW	168
4111G	138	SUPER SIMPLEX E	159
4113CE	52	SUPER SIMPLEX E R	160
4113I	52	SUPER SIMPLEX M	159
4120R	54	THF ALTA PRESIÓN	176
4123G	138		
41302G	137		
41303G	137		
4131G	136		
4132G	137		

DICCIONARIO TECNICO

FORMACIÓN BÁSICA DE CONCEPTOS Y PRODUCTOS

CONCEPTOS

DN

Abreviación de Diámetro Nominal. Indica el diámetro interior de paso del fluido por dentro de tuberías, válvulas o accesorios.

PN

Abreviación de Presión Nominal. Indica la presión interior máxima de trabajo en condiciones de temperatura ambiente y presión exterior atmosférica. El límite de presión de trabajo es una curva que va decreciendo en función del aumento de temperatura. La correcta aplicación de una válvula se realiza primero con la determinación de las condiciones de temperatura y presión y su comprobación de que el punto de trabajo siga dentro de las condiciones mecánicas de funcionamiento de esta.

PÉRDIDA DE CARGA

Disminución de la energía dinámica del fluido producido por la fricción con las paredes, su propia fricción entre sus partículas. Los cambios bruscos de dirección o de diámetro aumentan las pérdidas de carga de manera significativa.

GOLPE DE ARIETE

Fenómeno de aumento excesivo de la presión producido en las instalaciones hidráulicas cuando hay un cierre brusco del caudal del fluido. Es un fenómeno peligroso pues las presiones pueden aumentar muy por encima de las presiones nominales de los componentes y producir roturas en tuberías, accesorios y/o válvulas. La forma de evitar estos golpes de ariete es ralentizar el cierre de las válvulas o instalar algún mecanismo que pueda absorber el exceso de presión (Vasos de expansión, dispositivos antiariete como el de MT modelo 4160).

PASO TOTAL

Una válvula se puede considerar de Paso Total o Paso Completo cuando el paso del fluido es igual a su DN (Diámetro nominal). Según UNE-EN-13828.

PASO REDUCIDO

Una válvula se puede considerar de Paso Reducido cuando el paso del fluido es una medida inferior a su DN (diámetro nominal). Según UNE-EN-13828.

ESTANQUEIDAD

Concepto que nos indica que no pasa fluido a través de la válvula en posición de cierre ni por cualquier otro punto (eje, unión cuerpo-tapa, etc).

PAR DE GIRO

Fuerza medida en Nm que se ejerce para la apertura y cierre de la válvula. Es importante su valor para poder dimensionar correctamente un actuador. Las condiciones de trabajo, presión, temperatura, presión diferencial, densidad del fluido y viscosidad del fluido puede modificar significativamente el par de giro por lo que como mínimo se debe de tener un margen de seguridad del 30%.

TECHNICAL DICTIONARY

BASIC TRAINING OF CONCEPTS AND PRODUCTS

CONCEPTS

DN

Abbreviation of Nominal Diameter. Indicates the internal diameter of fluid passage through pipes, valves or fittings.

PN

Abbreviation of Nominal Pressure. Indicates the maximum internal working pressure under ambient temperature and atmospheric external pressure. The working pressure limit is a curve that decreases depending on the temperature increase. The correct application of a valve is first carried out with the determination of the temperature and pressure conditions and its verification that the working point remains within its mechanical operating conditions.

HEAD LOSS

Reduction of the dynamic energy of the fluid produced by friction with the walls, its own friction between its particles. Sudden changes in direction or diameter increase load losses significantly.

WATER HAMMER

Phenomenon of excessive increase of the pressure produced in the hydraulic installations when there is an abrupt closure of the fluid flow. It is a dangerous phenomenon because the pressures can increase well above the nominal pressures of the components and cause breaks in pipes, fittings and / or valves.

The way to avoid these water hammers is to slow down the closing of the valves or install some mechanism that can absorb excess pressure (expansion vessels, anti-cracking devices such as MT model 4160).

FULL BORE

A valve can be considered as Total Pass or Full Pass when the fluid flow is equal than its DN (Nominal Diameter). According to UNE-EN-13828.

REDUCED BORE

A valve can be considered a Reduced Pass when the fluid flow is one size smaller than its DN (Nominal Diameter). According to UNE-EN-13828.

SEALING

Concept that indicates that no fluid passes through the valve in the closed position or any other point (stem, body-cover joint, etc).

TORQUE

Force measured in Nm used to open or closing the valve. Its value is important in order to determinate the correct size for actuator. The working conditions, pressure, temperature, differential pressure, fluid density and fluid viscosity can significantly change the torque so that at least a safety margin of 30% must be had.

MATERIALES

HIERRO

Metal común frágil y con poca resistencia de la dureza y oxidación. En nuestro caso, lo galvanizamos (tratamiento químico), para darle una mayor resistencia a la oxidación.

LATÓN

El latón es una aleación de Cobre y Zinc. Muy usado en valvulería para edificación por su facilidad de manipulación combinada a su características mecánicas y su resistencia a la oxidación.

Propiedades:

- Buena resistencia a la oxidación.
- Excelente mecanización en frío.
- Excelente capacidad de recubrirse, como niquelados, galvanizados y cromados
- Excelente soldabilidad.

Existen diferentes tipos de latones, las normas que los definen son la EN-12164, EN-12165.

La tendencia actual en Europa es la de cambiar a latones tipo DZR con mayores propiedades oxidantes y latones con menores o nulas cantidades de plomo.

ACERO INOXIDABLE

Los productos de MT utilizan básicamente dos tipos de Aceros Inoxidable. Se usan para válvulas que la exigencia mecánica alta, y el fluido y ambiente son corrosivos.

A304, A304L: Acero Inoxidable Austenítico con unas buenas propiedades oxidante.

A316, A316L: Acero Inoxidable Austenítico con unas mejores propiedades oxidante que el A304 por la adición de Molibdeno.

Propiedades:

- Excelente resistencia a la oxidación.
- Buena mecanización en frío.
- Buena soldabilidad en las versiones "L" de bajo contenido en carbono (A304L y A316L)
- Muy buenas propiedades mecánicas. Gran tenacidad.

Las condiciones mecánicas de estos aceros pueden variar según la forma de enfriamiento y por los tratamientos térmicos. La norma EN-10088 los describe.

FUNDICIÓN GRIS

Aleación de hierro, carbono y otros elementos en menores cantidades. Se usa para válvulas que la exigencia mecánica no sea grande, y el fluido y ambiente no son corrosivos. Propiedades:

- Baja resistencia a la oxidación.
- Baja dureza.
- Frágilidad media.
- Buenas propiedades mecánicas.
- Excelente mecanización en frío.

Las válvulas de fundición gris van recubiertas por pinturas epoxi para mejorar notablemente su resistencia a la oxidación.

FUNDICIÓN NODULAR O DÚCTIL

Aleación de hierro, carbono y otros elementos en menores cantidades. Aumento de la Dureza y la resistencia a la fatiga.

Se usa para válvulas que la exigencia mecánica es medias, y el fluido y ambiente no son corrosivos.

Propiedades:

- Baja resistencia a la oxidación.
- Mejora la dureza de la fundición gris.
- Mejora la fragilidad de la fundición gris.
- Buenas propiedades mecánicas, mejores que la fundición gris.
- Excelente mecanización en frío.

Las válvulas de fundición dúctil también van recubiertas por pinturas epoxi para mejorar notablemente su resistencia a la oxidación.

ACERO AL CARBONO

Aleación de hierro con carbono. A diferencia de los aceros inoxidables tiene pocos elementos aleados. Son el tipo de aceros más producidos a nivel mundial.

Se usa para válvulas que necesitan unas propiedades mecánicas exigentes.

Propiedades:

- Baja resistencia a la oxidación.
- Mejora la dureza de la fundición gris.
- Mejora la fragilidad de la fundición gris.
- Buenas propiedades mecánicas, mejores que la fundición gris.
- Buena mecanización en frío.

Las válvulas de acero al carbono suelen protegerse con aceites y algunas con pintura epoxi para aumentar su resistencia a la oxidación.

NBR

Caucho de Nitrilo Butadieno (**N**itrile **B**utadiene **R**ubber). Elastómero procedente de caucho.

Propiedades:

- Compatible con hidrocarburos, petróleo y gasóleos.
- Compatible con agua para suministro humano.
- Las temperaturas de utilización van de los -20°C a los 80°C
- Gran resistencia a las deformaciones.
- Buena resistencia a la abrasión.

Algunas válvulas lo usan para sellar el eje en forma de junta tórica o en junta plana.

EPDM

Etileno Propileno Dieno tipo **M**, elastómero sintético.

Propiedades:

- No es compatible con hidrocarburos, petróleo y gasóleos.
- Compatible con agua para suministro humano.
- Las temperaturas de utilización van de los -20°C a los 120°C.
- Gran resistencia a las deformaciones.
- Buena resistencia a la abrasión.

Algunas válvulas lo usan para sellar el eje en forma de junta tórica o en junta plana.

FKM

Elastómero fluoropolímero.

Propiedades:

- Compatible con hidrocarburos, petróleo y gasóleos.

MATERIALS

IRON

Common metal fragile and with little resistance to hardness and oxidation. In our case, we galvanize it (chemical treatment), to give it greater resistance to oxidation.

BRASS

Brass is an alloy of Copper and Zinc. Widely used in building valves for ease handling combined with its mechanical properties and oxidation resistance.

Properties:

- Good oxidation resistance.
- Excellent cold machining.
- Excellent coating ability, such as nickel plated, galvanized and chrome plated.
- Excellent weldability.

There are different types of brass, the standards defining them are EN-12164, EN-12165.

The current trends in Europe are to switch to brass type DZR with higher oxidizing properties and brass with less or no lead content.

STAINLESS STEEL

MT products use basically two types of stainless steels. They are used for valves with high mechanical requirements, and the fluid and environment are corrosive.

A304, A304L: Austenitic Stainless Steel with good oxidizing properties.

A316, A316L: Austenitic Stainless Steel with better oxidizing properties than A304 by the addition of Molybdenum.

Properties:

- Excellent resistance to oxidation.
- Good cold machining.
- Good weldability in low carbon "L" versions (A304L and A316L)
- Very good mechanical properties. Great tenacity.

The mechanical conditions of these steels may vary depending on the form of cooling and the heat treatment. The standard EN-10088 describes them.

CAST IRON

Alloying of iron, carbon and other elements in smaller quantities. It's used for valves where the mechanical requirement is not large and the fluid and environment are not corrosive. Properties:

- Low resistance to oxidation.
- Low hardness.
- Medium fragility.
- Good mechanical properties.
- Excellent cold machining.

Cast iron valves are coated with epoxy paint to significantly improve their resistance to oxidation.

NODULAR OR DUCTILE IRON

Alloying of iron, carbon and other elements in smaller quantities. Increased hardness and fatigue resistance than cast iron.

It is used for valves whose mechanical requirements are average, and the fluid and environment are not corrosive.

Properties:

- Low resistance to oxidation.
- Improves the hardness of the gray foundry.
- Improves the fragility of the gray foundry.
- Good mechanical properties, better than the gray foundry.
- Excellent cold machining.

Ductile iron valves are also coated with epoxy paints to significantly improve their oxidation resistance.

CARBON STEEL

Iron alloy with carbon. Unlike stainless steels it has few alloyed elements. They are the most produced type of steels in the world. It is used for valves that require demanding mechanical properties.

Properties:

- Low resistance to oxidation.
- Improves the hardness of the gray foundry.
- Improves the fragility of the gray foundry.
- Good mechanical properties, better than the gray foundry.
- Good cold machining.

Carbon steel valves are usually protected with oils and some with epoxy paint to increase their resistance to oxidation.

NBR

Nitrile **B**utadiene **R**ubber. Elastomer from rubber.

Properties:

- Compatible with hydrocarbons, oil and diesel.
- Compatible with water for human supply.
- The operating temperatures range from -20°C to 80°C.
- High resistance to deformations.
- Good abrasion resistance.

Some valves use it to seal the shaft in the form of a O-ring or a flat joint.

EPDM

Ethylene **P**ropylene **D**iene type **M**, synthetic elastomer.

Properties:

- Not compatible with hydrocarbons, oil and gas.
- Compatible with water for human supply.
- The operating temperatures range from -20°C to 120°C.
- High resistance to deformations.
- Good abrasion resistance.

Some valves use it to seal the shaft in the form of a O-ring or a flat joint.

FKM

Fluoropolymer elastomer.

Properties:

- Compatible with hydrocarbons, oil and diesel.
- Compatible with water for human supply.
- Use temperatures range from -20°C to 180°C.
- High resistance to deformations.
- Good resistance to high temperatures.

- Compatible con agua para suministro humano.
- Las temperaturas de utilización van de los -20°C a los 180°C.
- Gran resistencia a las deformaciones.
- Buena resistencia a altas temperaturas.
- Se puede usar como cierre para válvulas en instalaciones de solar térmica.

Algunas válvulas lo usan para sellar el eje en forma de junta tórica o en junta plana.

PTFE

Elastómero sintético, **politetrafluoretileno**.

Propiedades:

- Compatible con la mayoría de químicos.
- Compatible con agua para suministro humano.

- Las temperaturas de utilización va de los -270°C a los 280°C
- Buena resistencia a temperaturas cercanas al cero absoluto y a altas temperaturas.
- Es el material con el menor coeficiente de fricción conocido.
- Se puede usar como cierre para válvulas en instalaciones de solar térmica.
- Fácil mecanización.
- Se puede mezclar con grafito o fibra de vidrio para mejorar sus propiedades mecánicas.

Algunas válvulas lo usan para sellar el eje en forma de junta plana.

Can be used as a shutoff for valves in solar thermal installations. Some valves use it to seal the shaft in the form of a O-ring or a flat joint.

PTFE

Synthetic elastomer, **polytetrafluoroethylene**.

Properties:

- Compatible with most chemicals.
- Compatible with water for human supply.
- The operating temperatures range from -270°C to 280°C.

- Good resistance to temperatures close to absolute zero and high temperatures.
- It's the material with the lowest known coefficient of friction.
- Can be used as a valve closure in solar thermal installations.
- Easy machining.
- Can be mixed with graphite or fiberglass to improve its mechanical properties.

Some valves use it to seal the shaft in the form of a flat joint



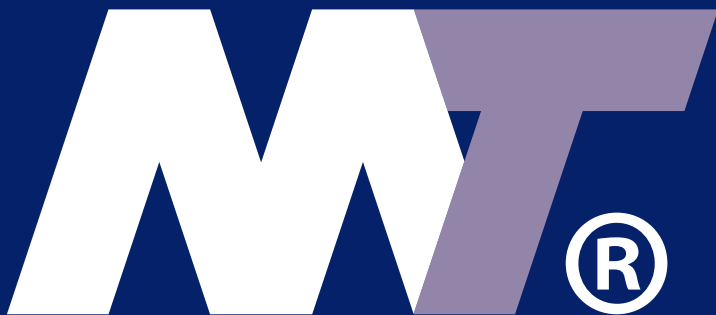

VALVES AND FITTINGS

mtspain.net

tel. +34 **936 804 980**
info@mtspain.net

V4